

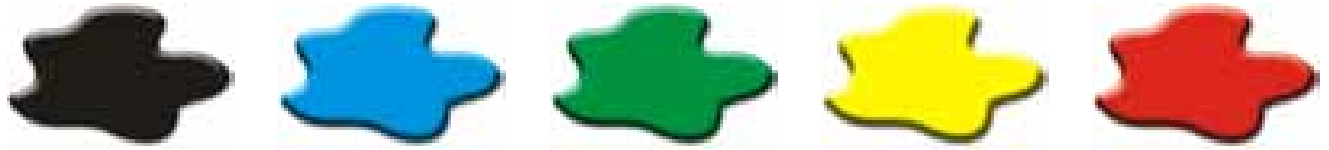

أتعلم الألوان

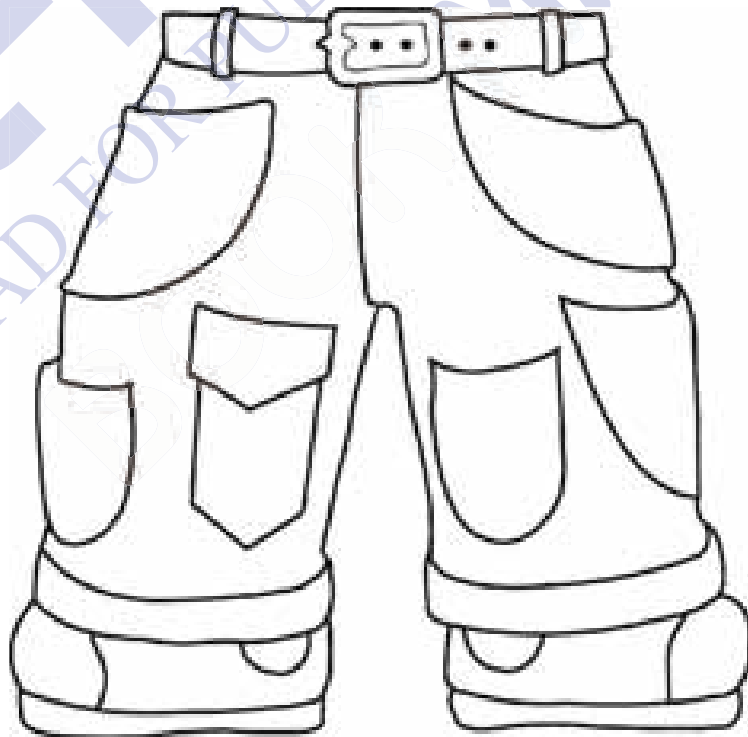

ألون



• أتعلم الأشكال

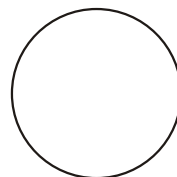
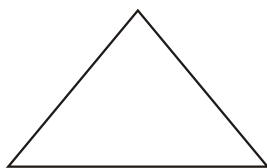
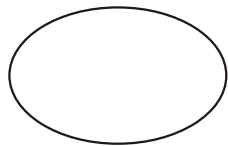

• أصل

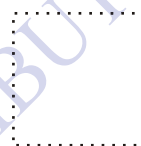
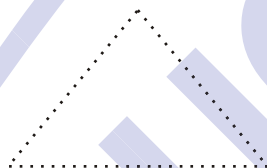

• ألون

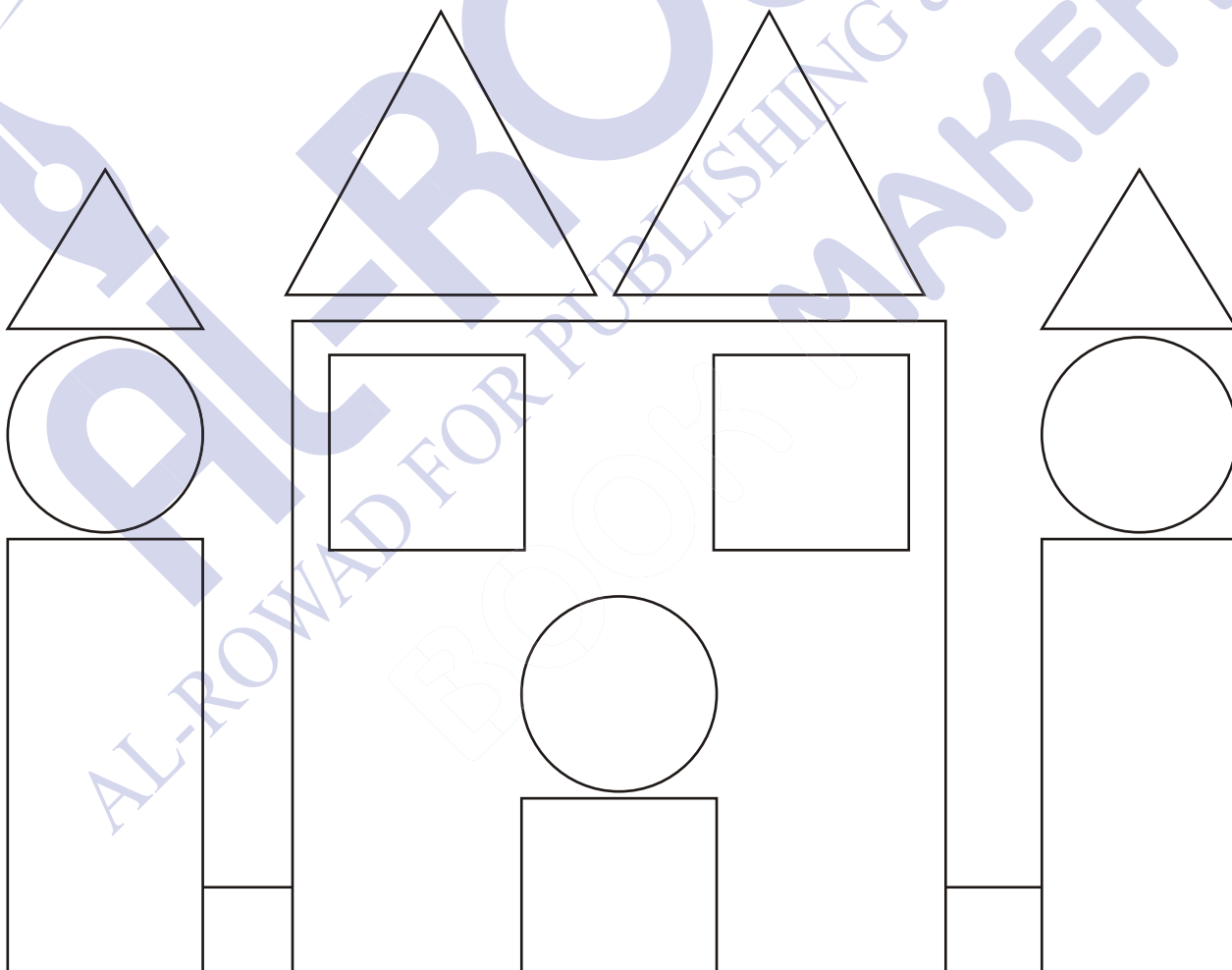

أصل الشكل واللون المشابه

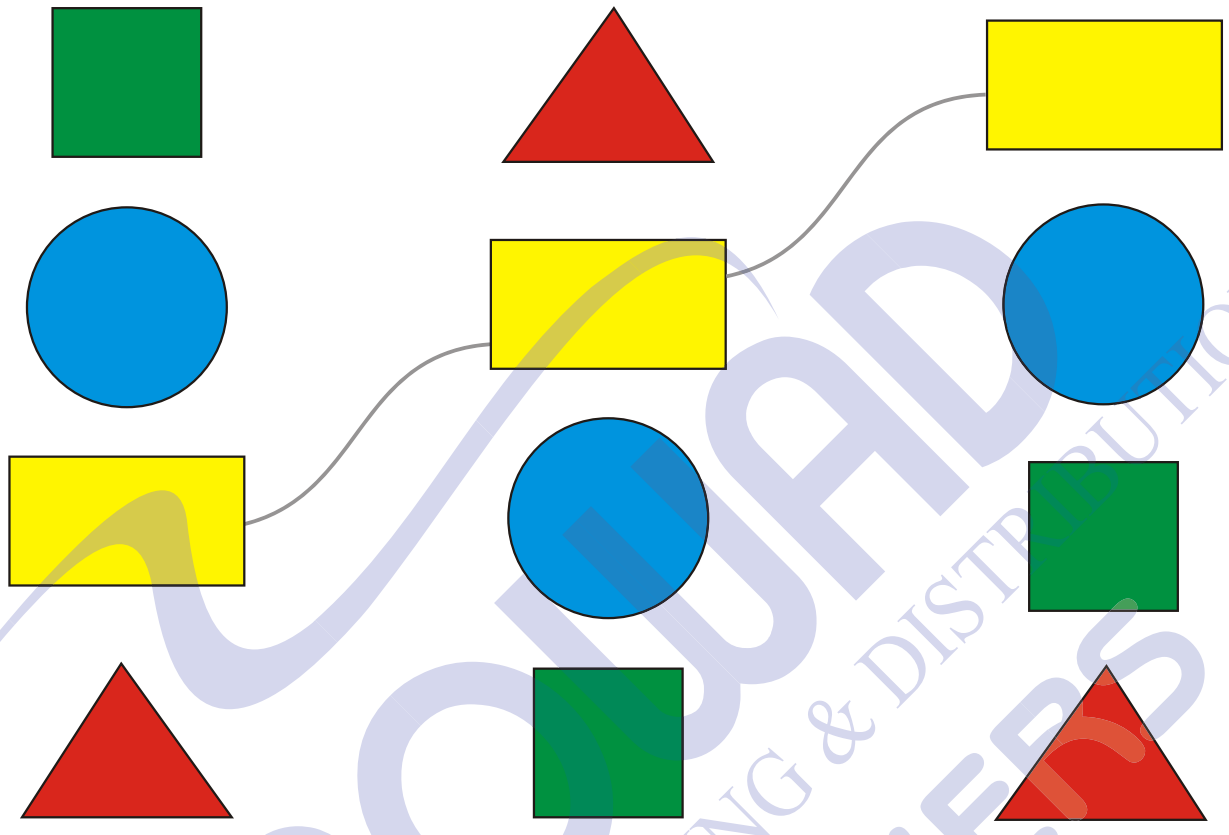

أصل الشكل والرقم المشابه

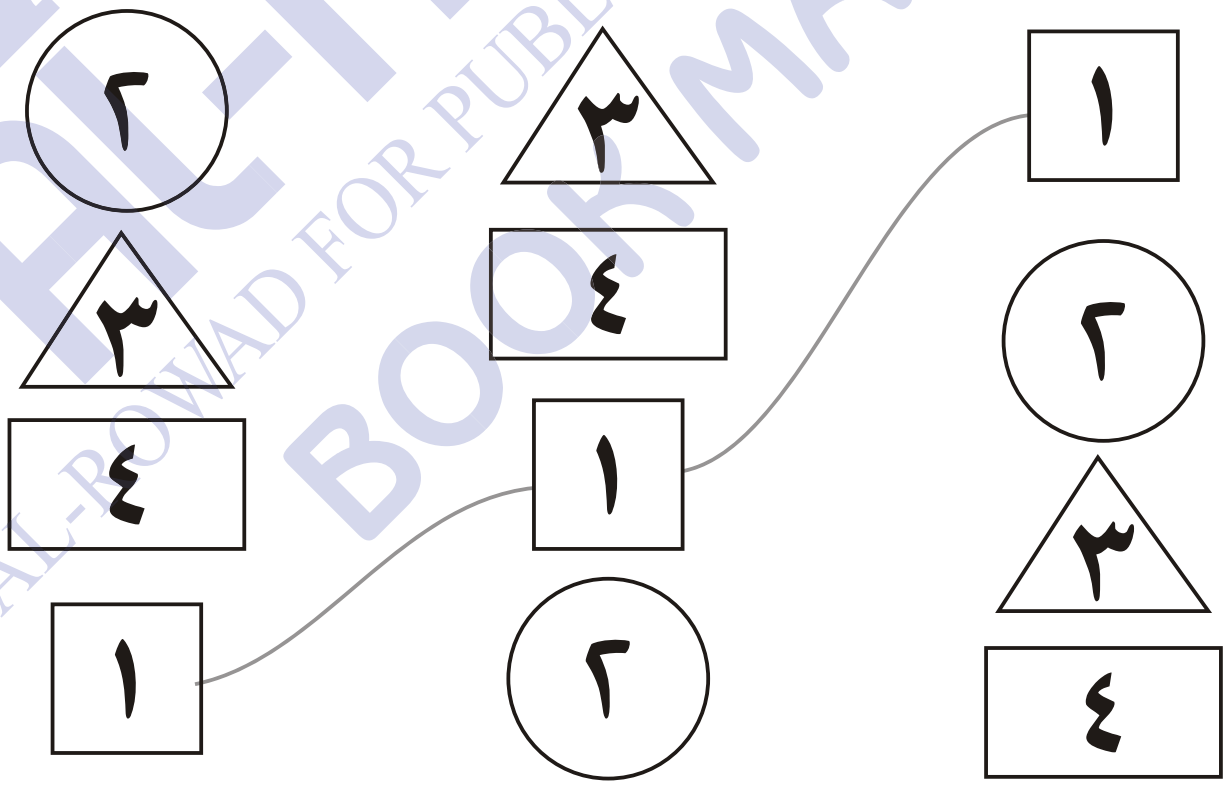

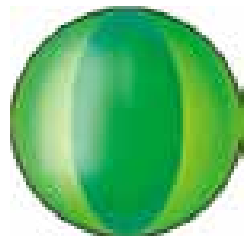
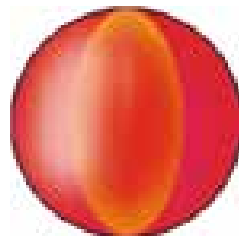
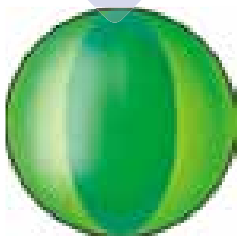
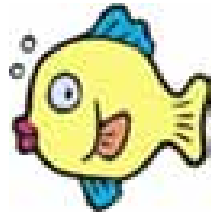
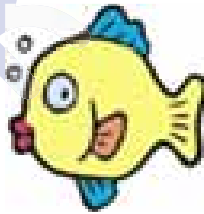
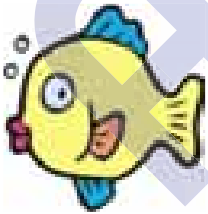
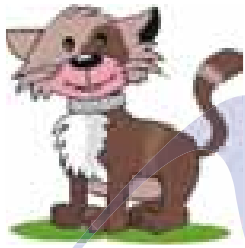

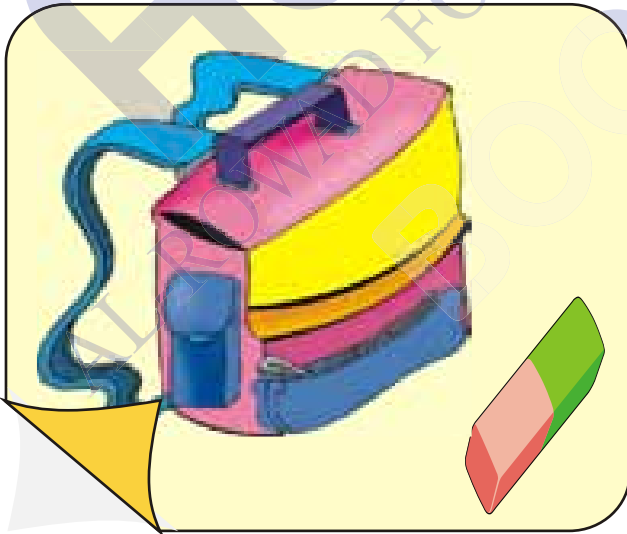
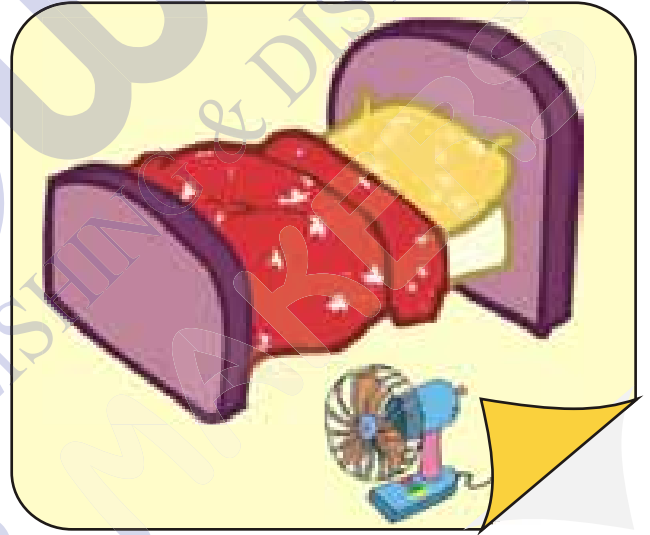
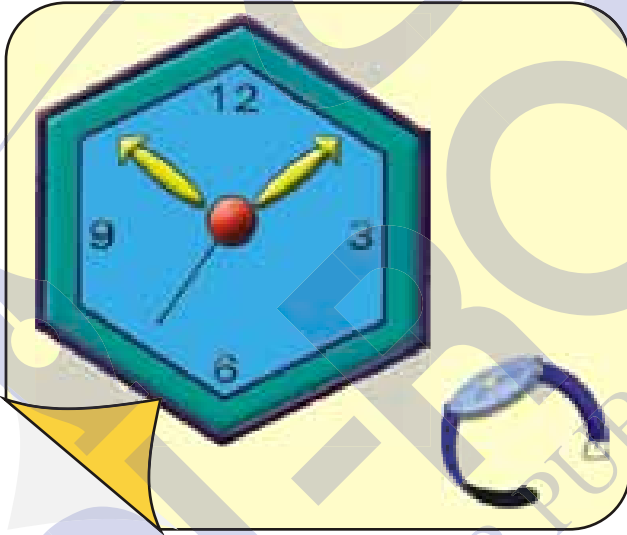
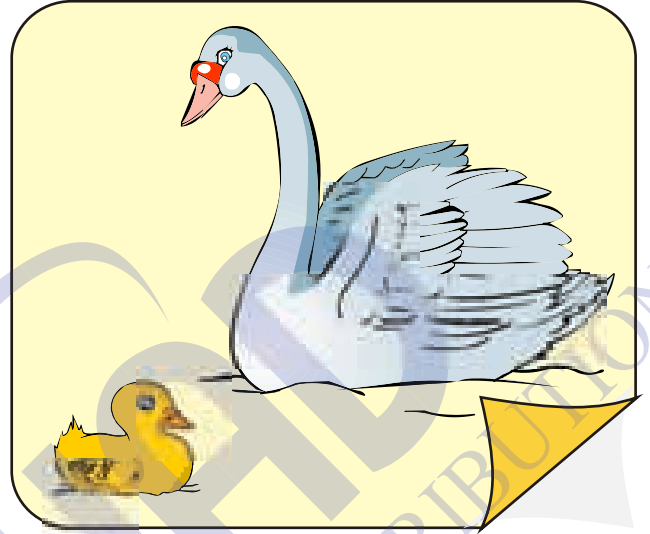

ألون العنصر الكبير باللون الأحمر واللون الصغير بالأزرق

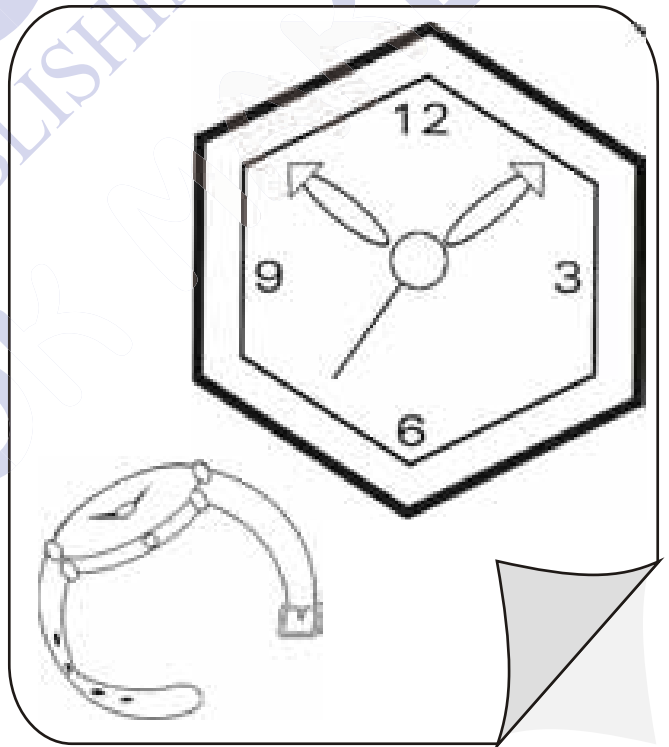
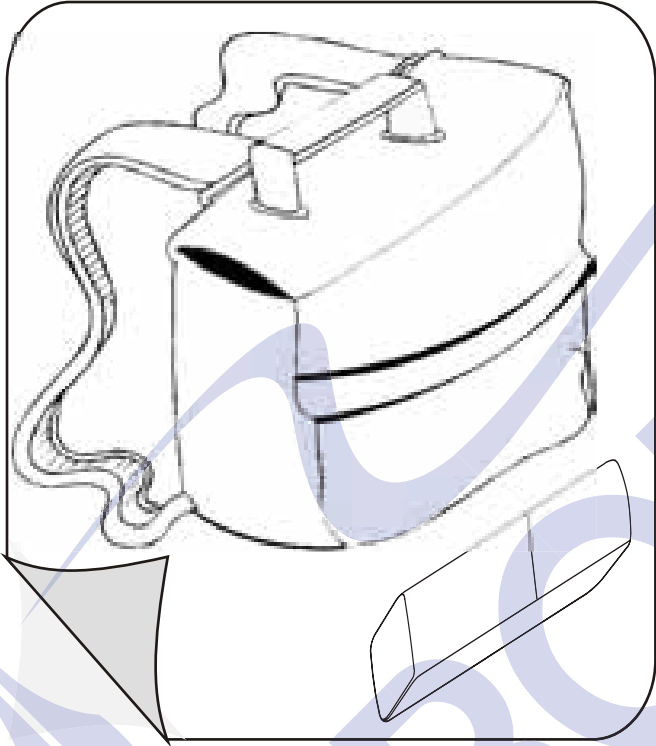

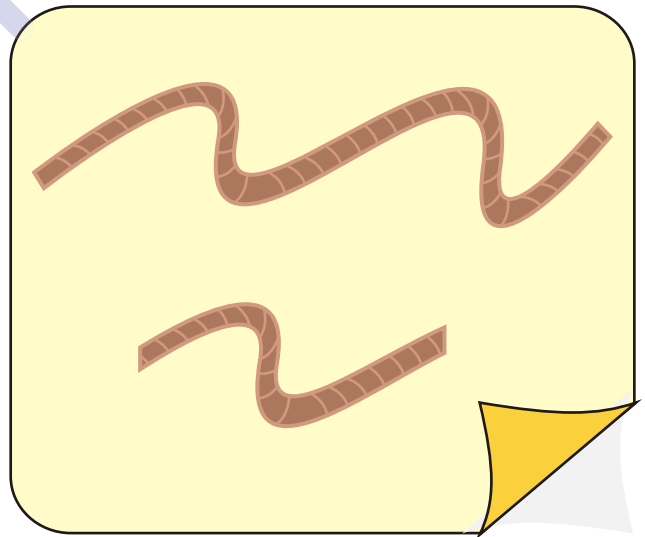
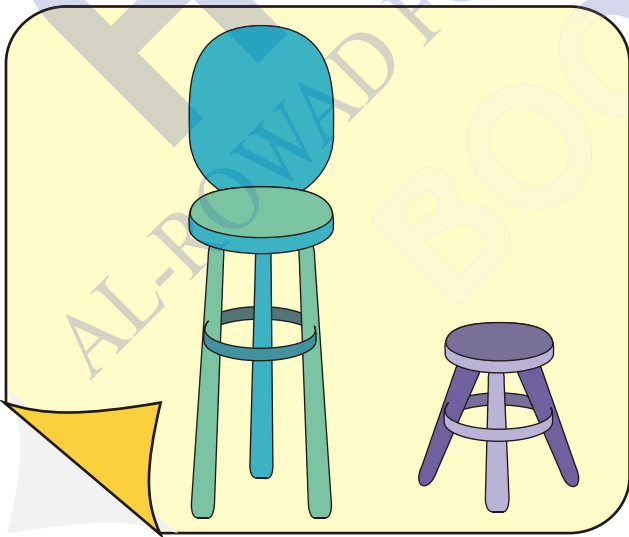
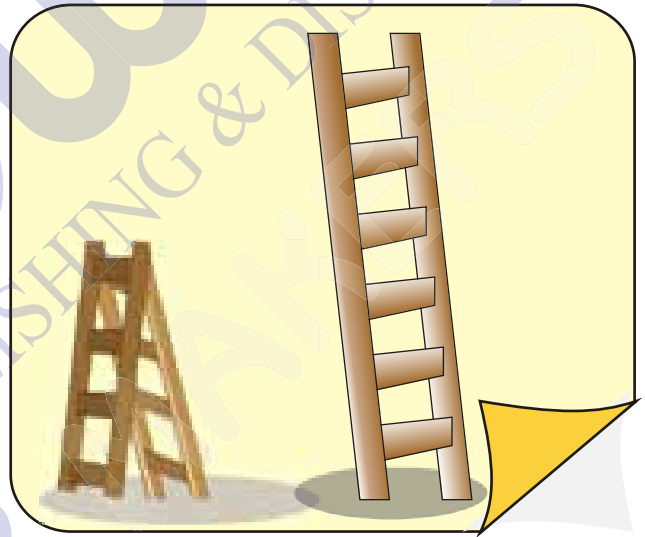
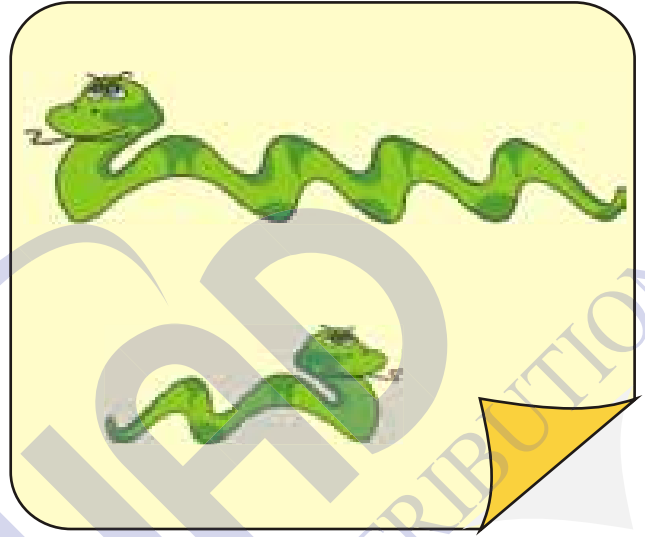
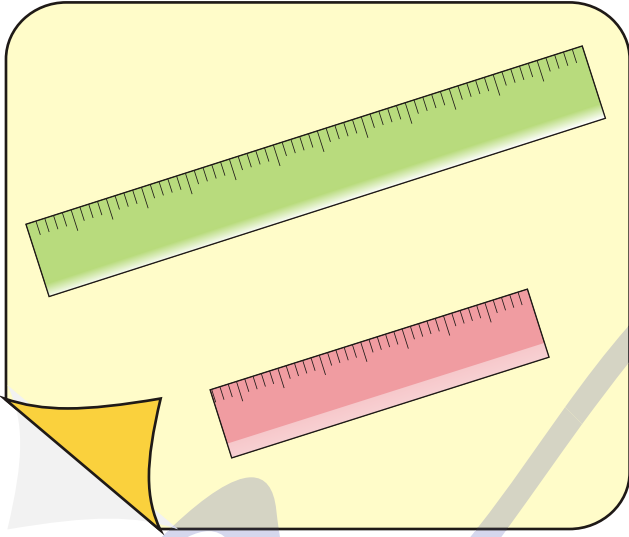

ألون العنصر الطويل باللون الأخضر والعنصر القصير باللون الأصفر

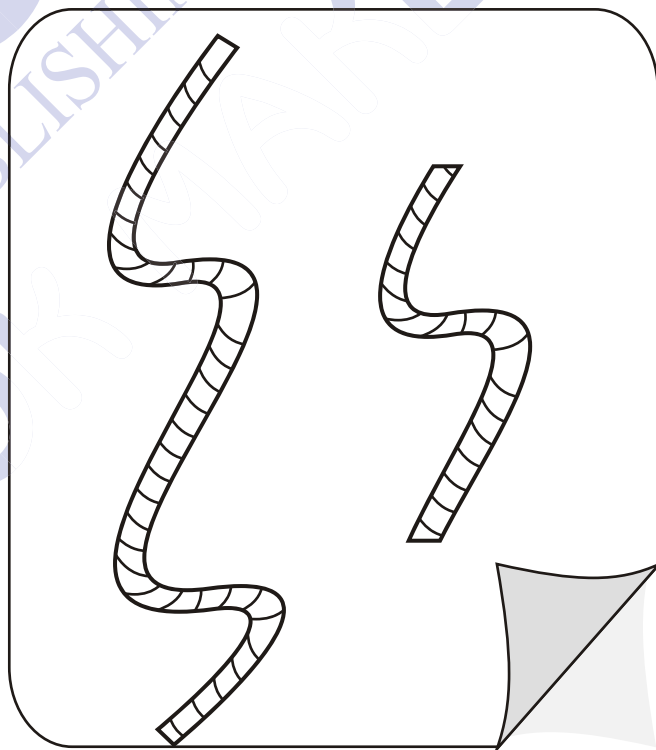
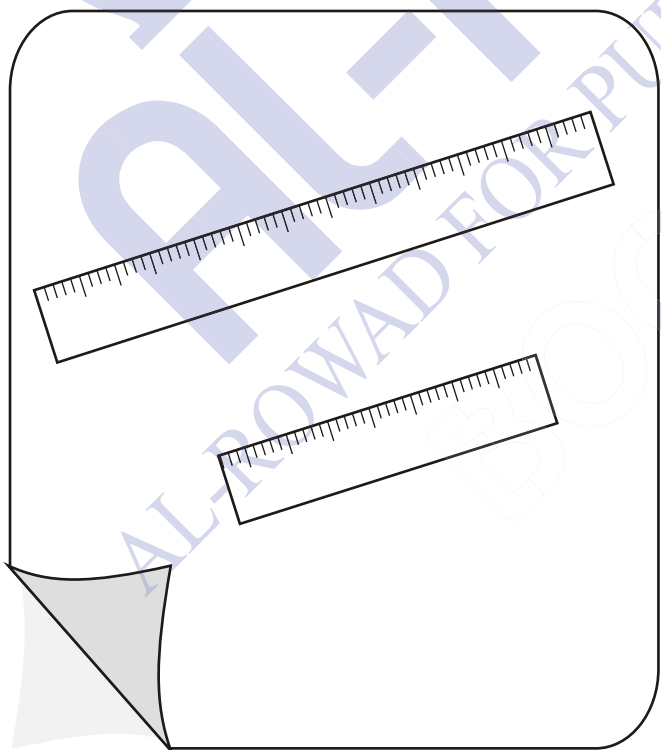
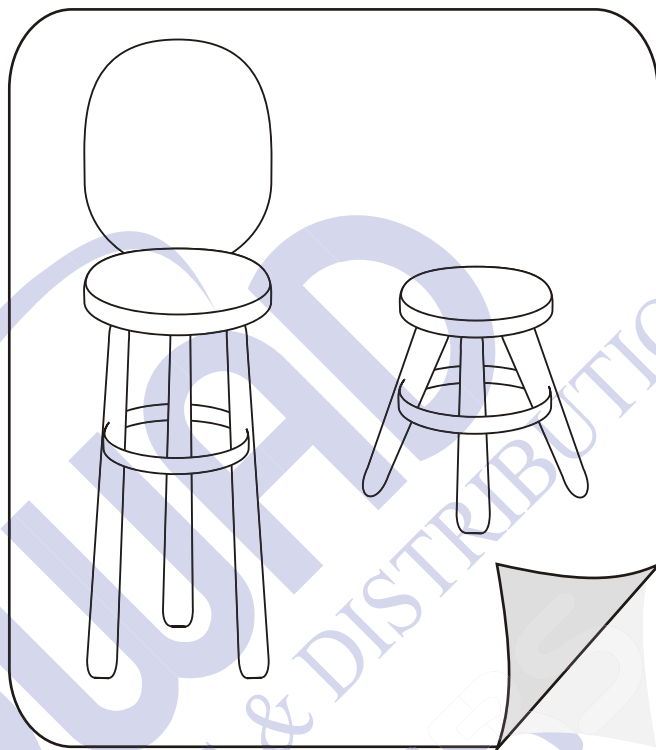
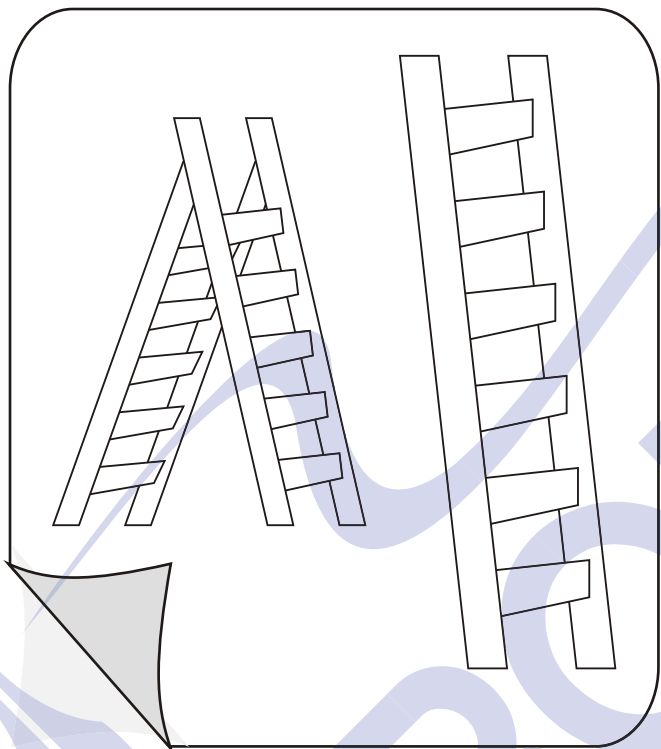

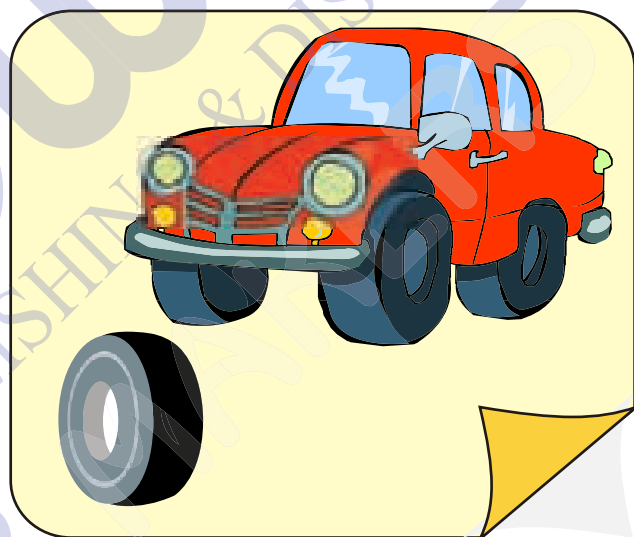
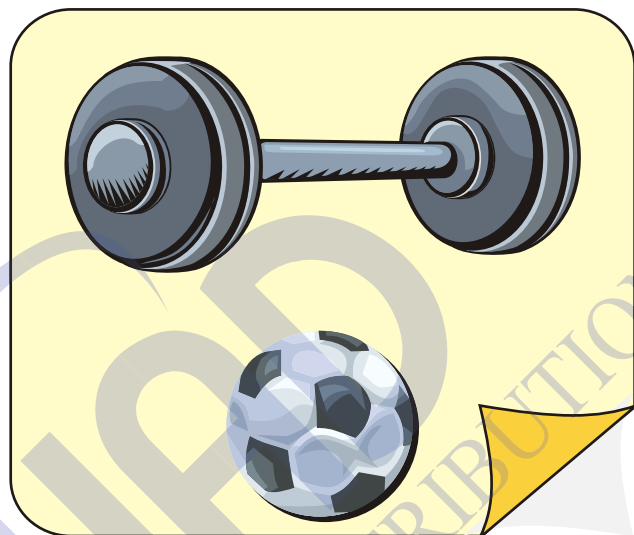
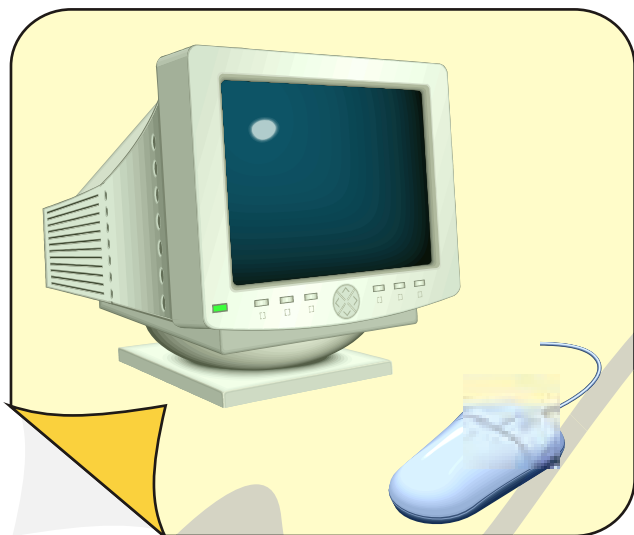

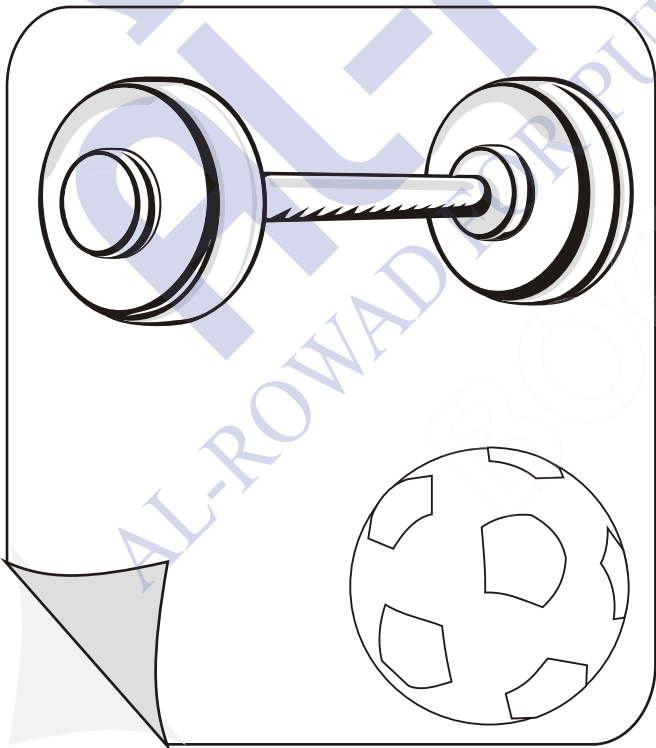
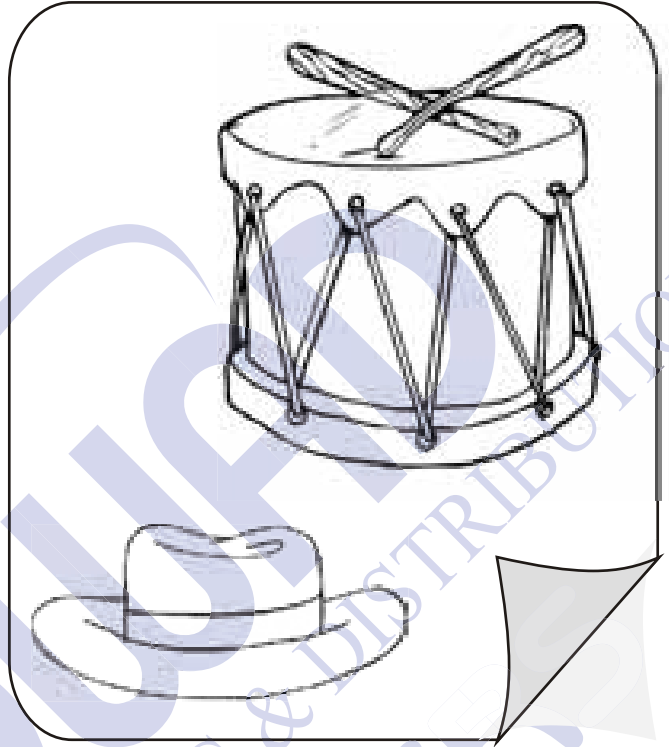
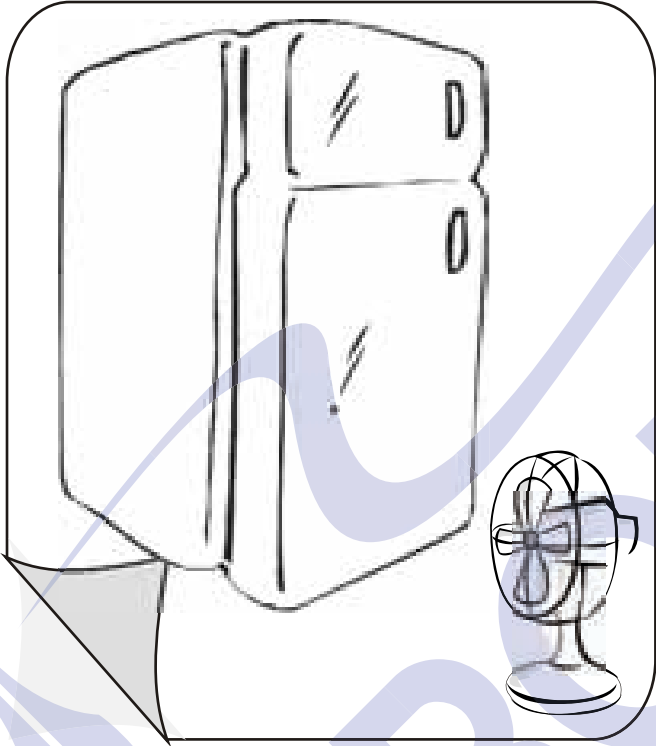



أكتب:

أتعلم



أكتب:

⋮	⋮	⋮	⋮	⋮	⋮	⋮	⋮
							⋮

ألون عنصراً واحداً من كل مجموعة:

أتعلم

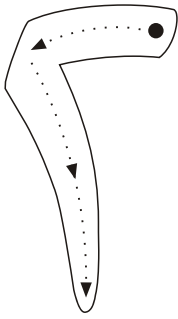

أكتب:

أضع دائرة حول الرقم المناسب

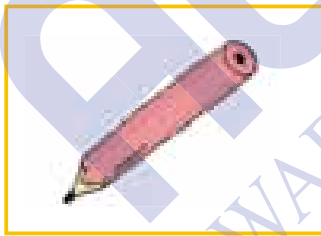

٢ ١



٢ ١



٢ ١



٢ ١

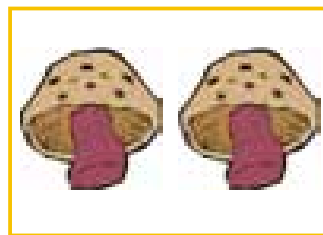

٢ ١

أتعلم

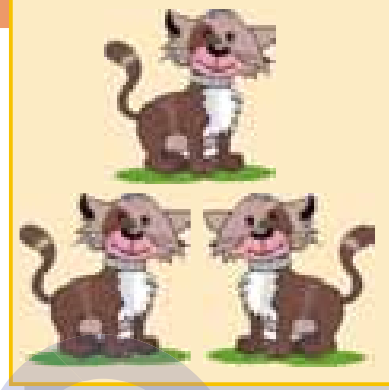
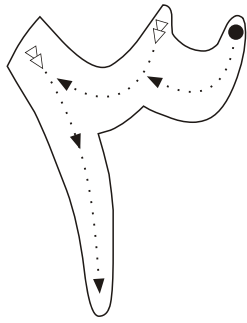

أكتب:

أضع خطأً حول ثلاثة عناصر فقط:

