

# Funny Numbers

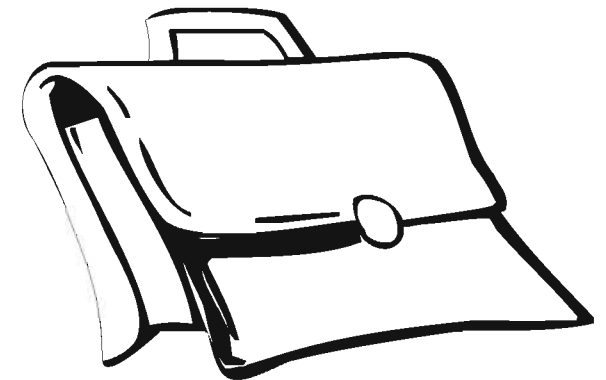

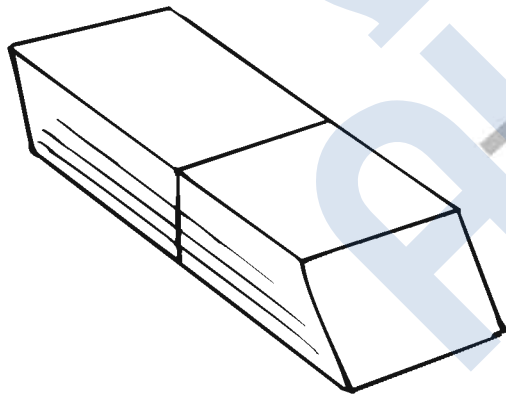
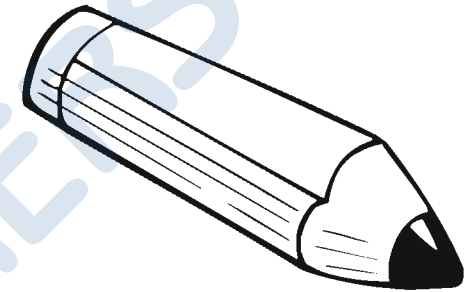
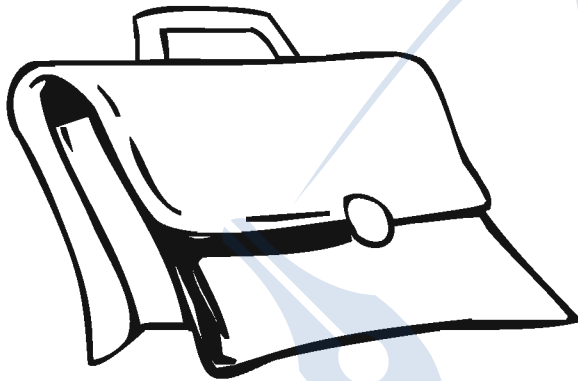
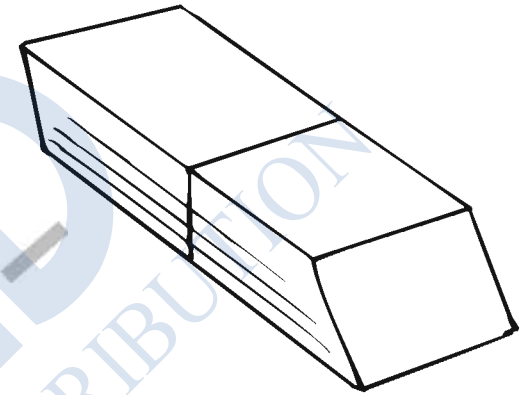
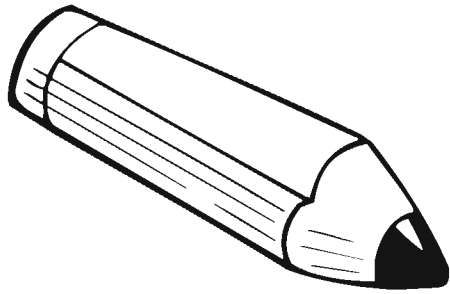

---

2

### Match identical pictures

Review vocabulary: rubber, pencil, bag. Draw lines to connect the matching objects.

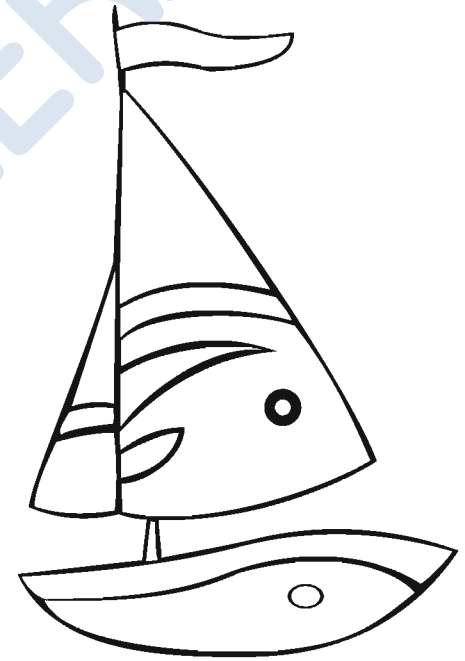
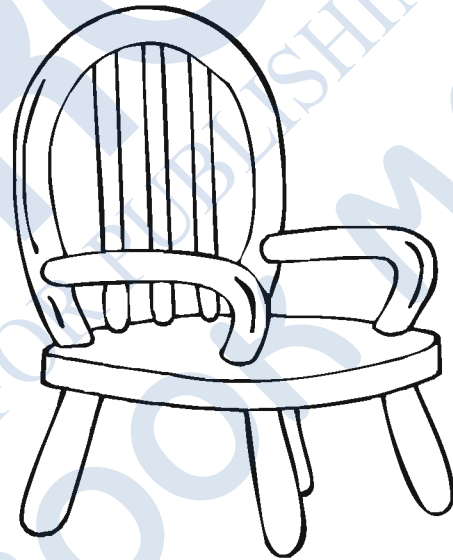
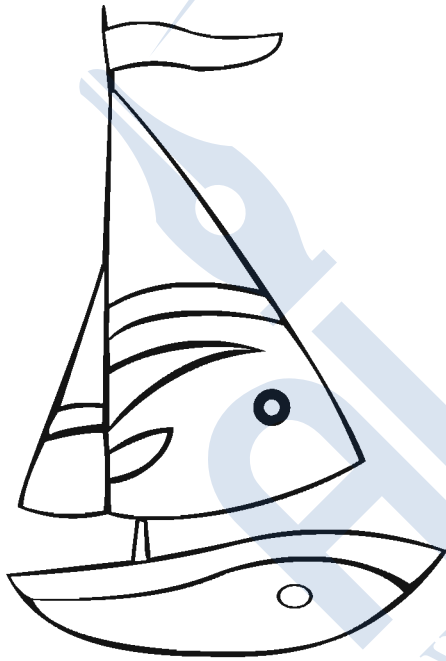
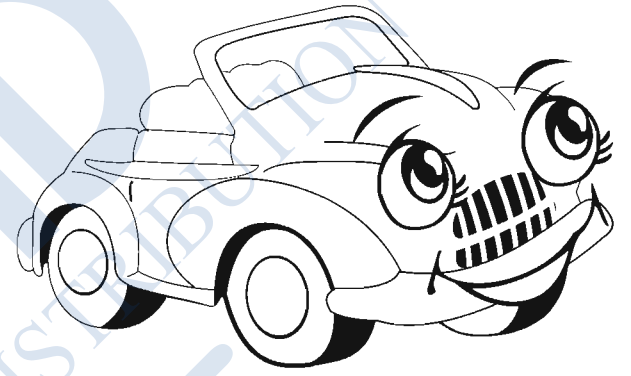
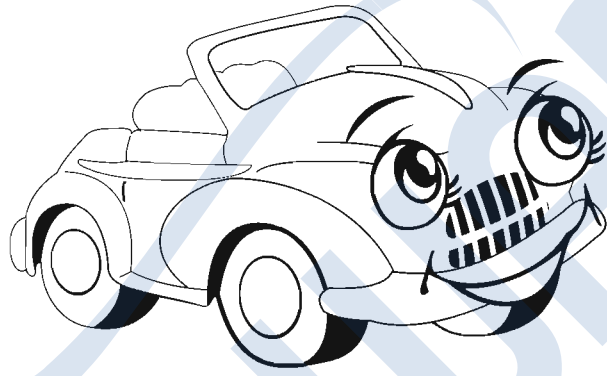
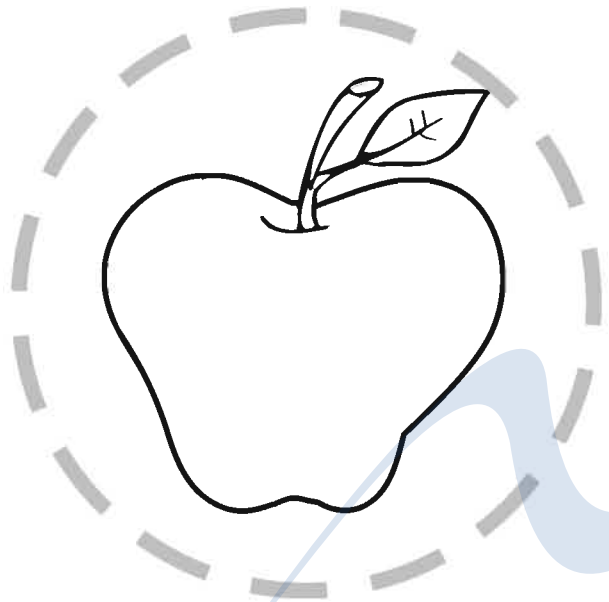

**Circle the odd picture out**

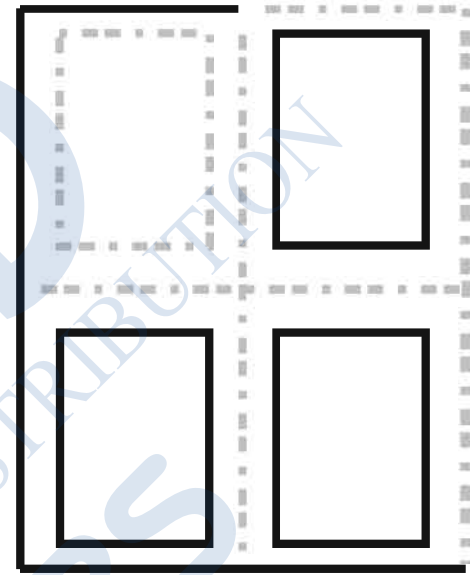
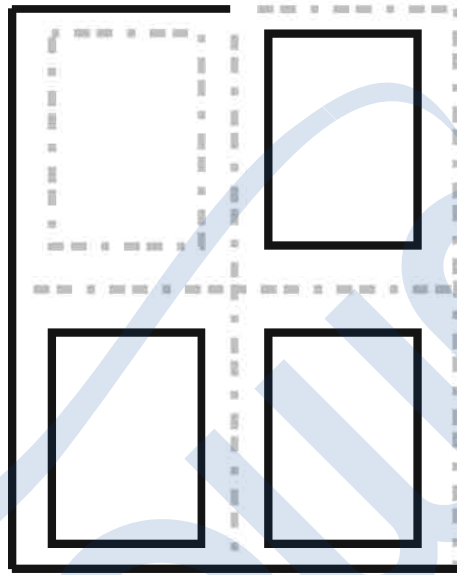
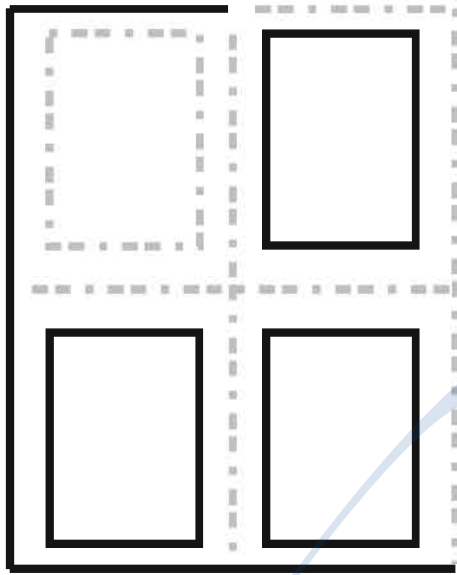

---

# 4

## Writing preparation

Complete the windows and clouds by tracing the dotted lines.

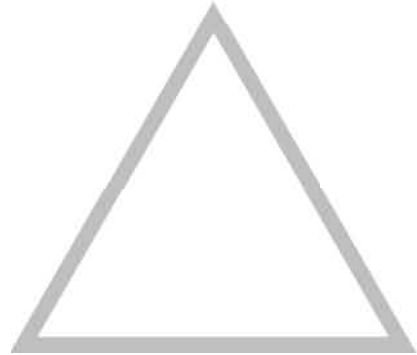
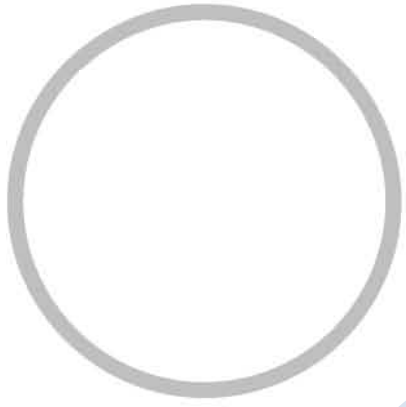

---

**Match identical pictures**

Vocabulary: circle, square, triangle. Name the shapes you see.



6

## Classify

Review vocabulary: triangle, circle, square, red. Colour the crayon red, then colour all squares red.

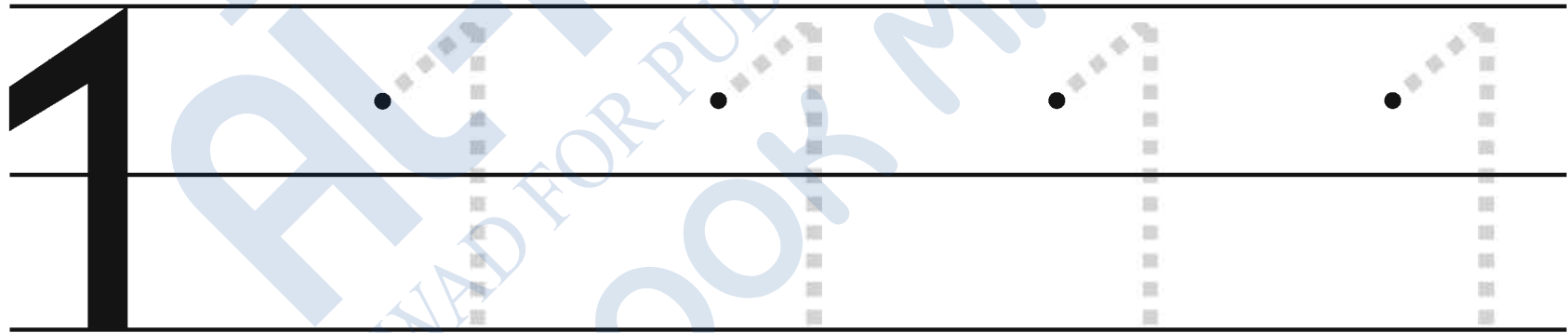
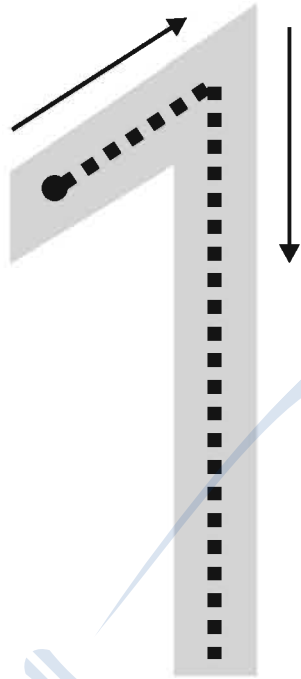

**Recognize and write numbers**

Trace the dotted numeral 1. Colour the sun.

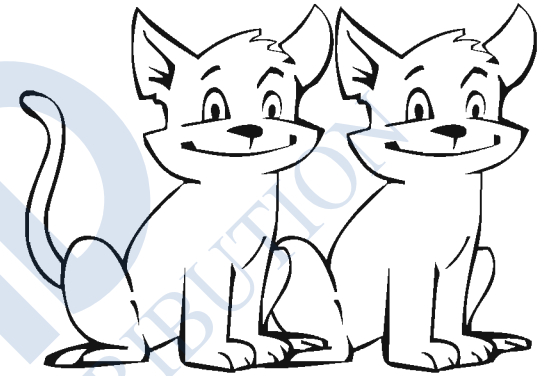
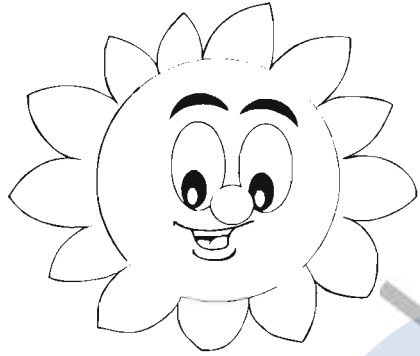

1

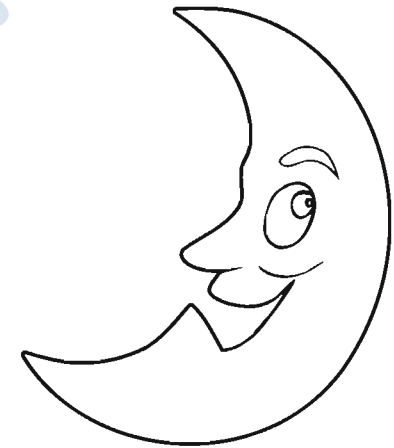
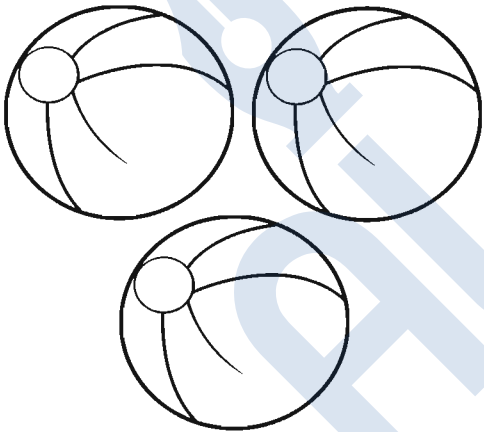

8

## Count

Draw a line from the numeral 1 to each picture showing a set of one.



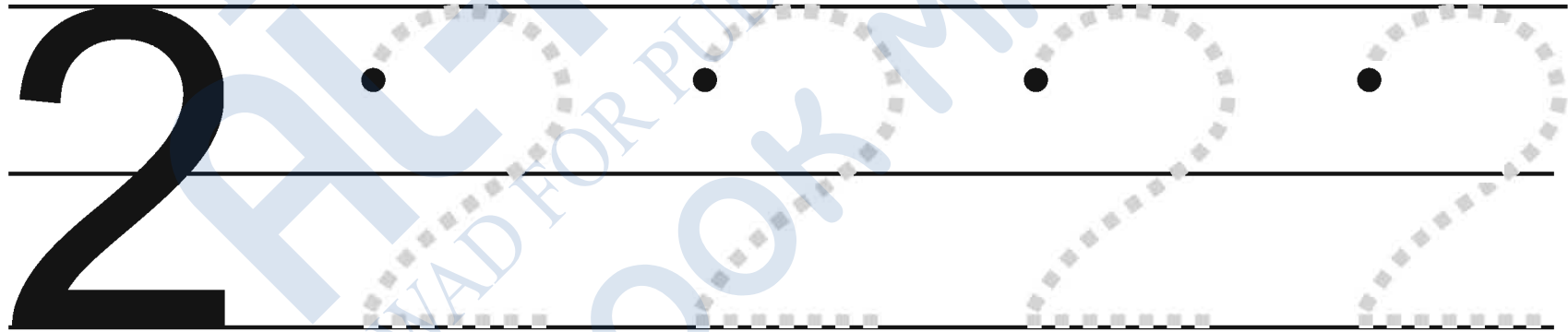
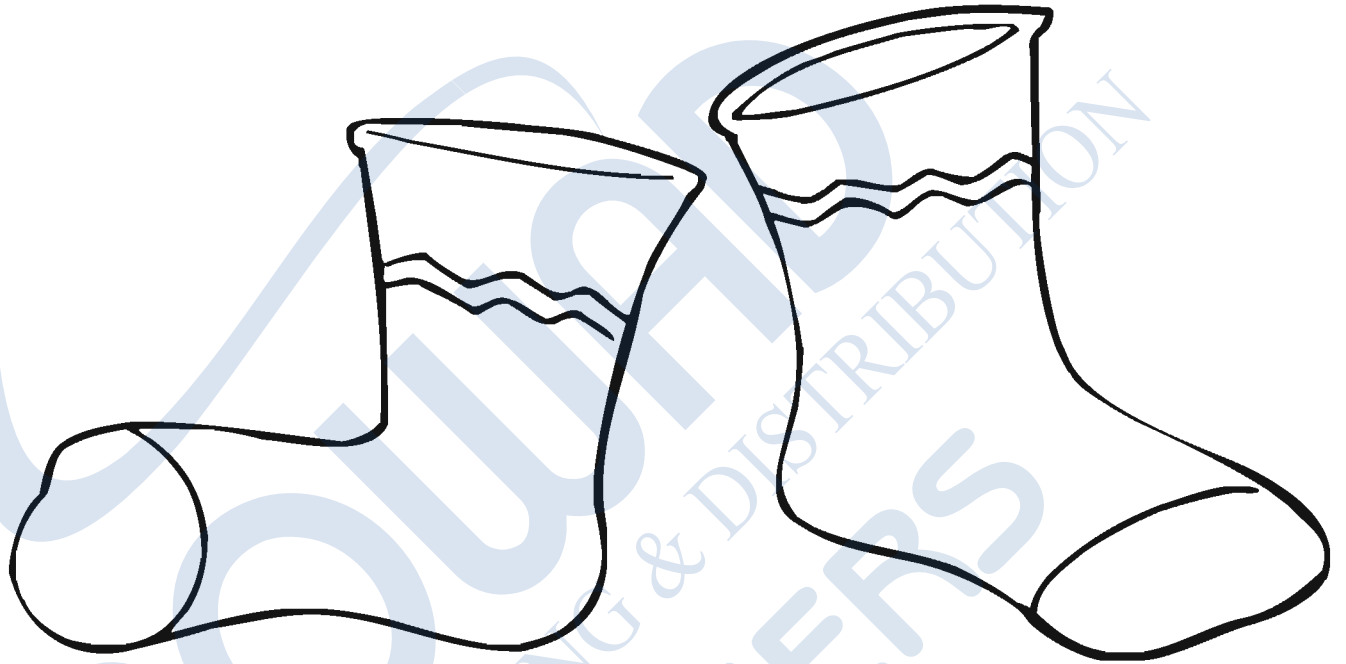
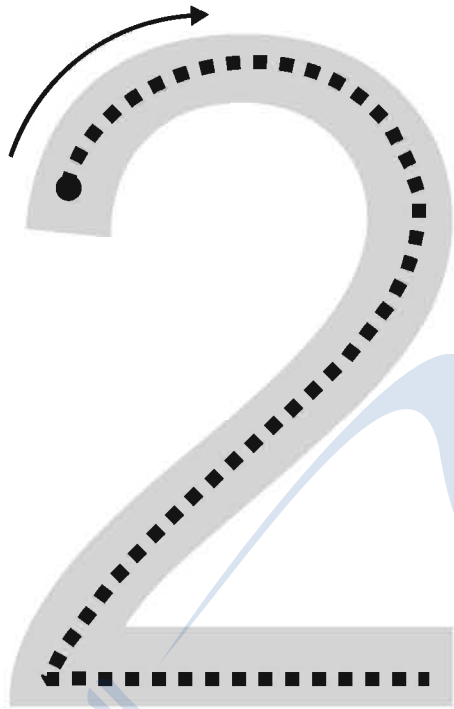

**Recognize and write numbers**

Trace the dotted numeral 2. Colour the socks.

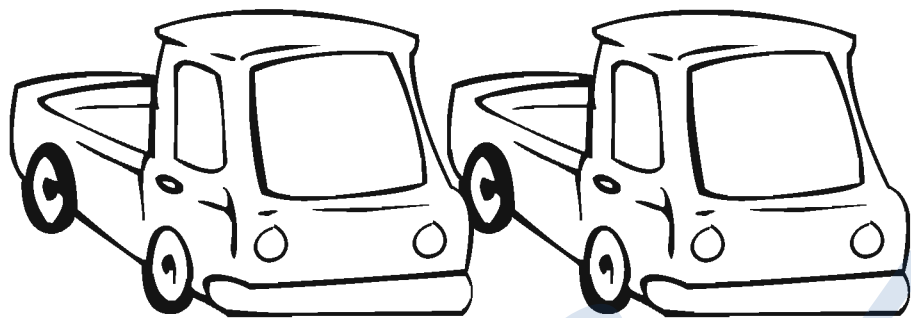

1

2

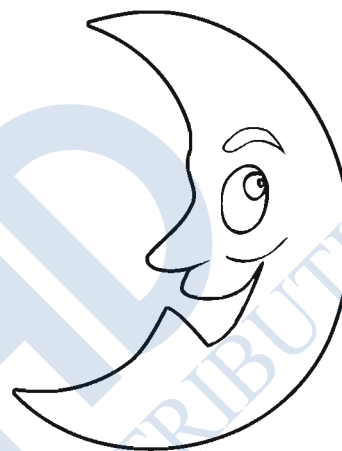

1

2

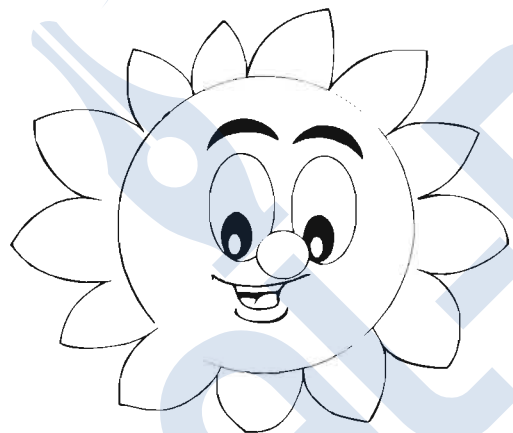

1

2

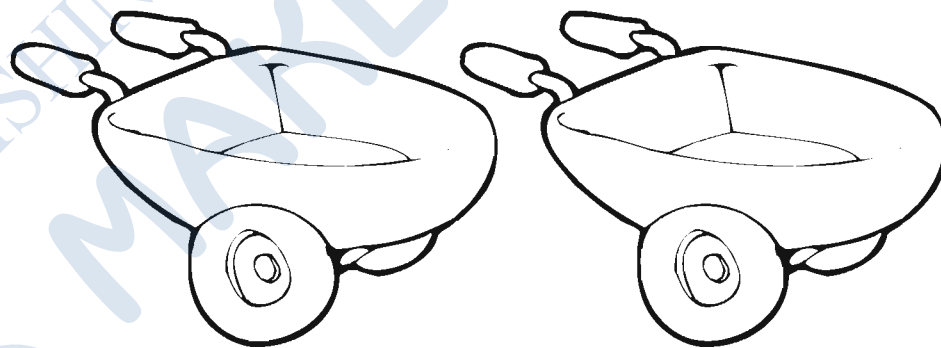

1

2

10

**Count then circle**

Count the pictures in each set. Circle the correct number.