

New

# English Splash 1



Small Letter

Rasha Al-Shafee

AL-RROWAD  
www.alrowadpub.com

# New English Splash 1

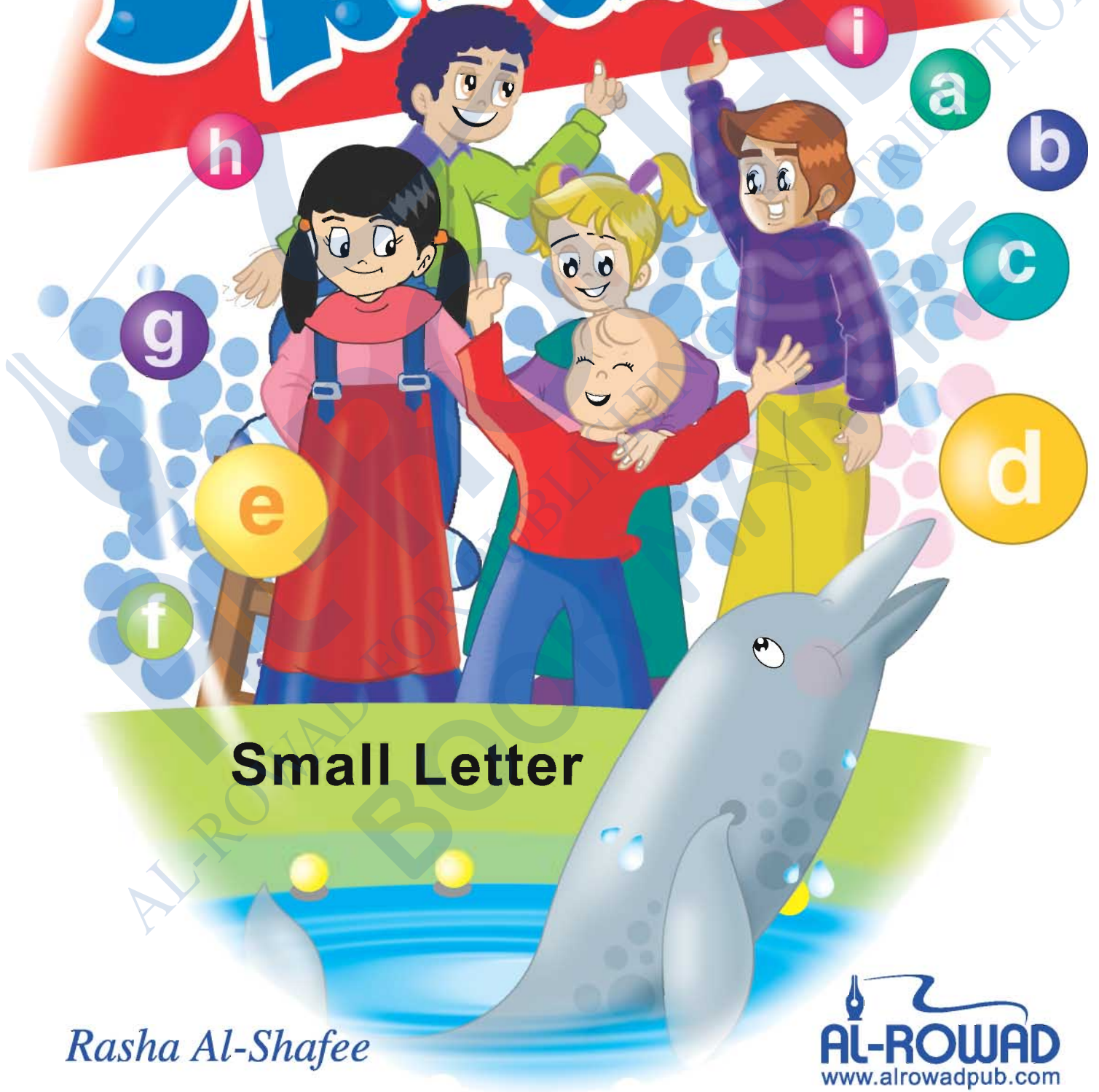

Small Letter

Rasha Al-Shafee

AL-ROWAD  
www.alrowadpub.com

**ALROWAD** for Publishing & Distribution

Jordan - Amman

Alabdali - Block No. 8

ISBN 978-9957-37-169-2

Text © Mrs. Rasha Alshafee 2010

Design and illustration © **ALROWAD** for Publishing & Distribution

First published 2007

All rights reserved; no part of this publication may be reproduced, stored in a retrieval system, transmitted in any form, or by any means, electronic, mechanical, photocopying, recording, or otherwise, without the prior written permission of the publishers.

Design by Fuad Elayyan      Design officer, **ALROWAD** for Publishing & Distribution  
Amal Hassan      Graphic Design, **ALROWAD** for Publishing & Distribution

Illustrated by Naseem Imteer

Cover design by Fuad Elayyan

Printed and bound in Jordan

2010    2011    2012    2013    2014

Photo

Name: .....

Class: .....

School: .....





Hello , hello.



How are you?

How are you?

I'm fine thank you.



I'm fine to see you.

How do you do? How do you do?

So nice to meet you.

So nice to meet you.

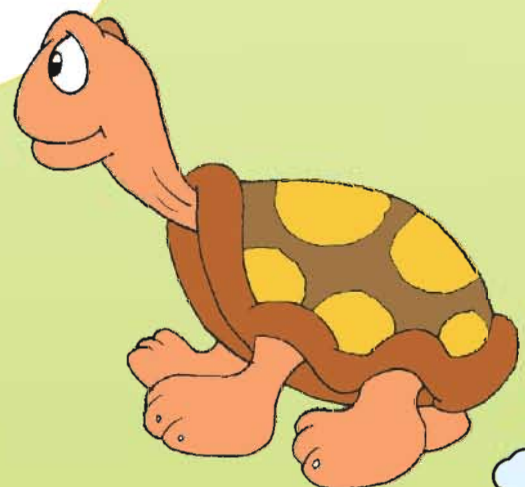

Hello.

Hello.  
I am Laila.

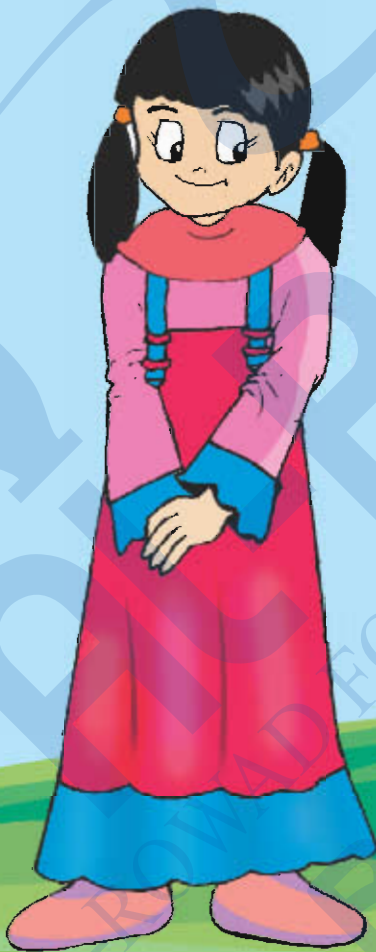

Hello.  
I am Salama





Hello.  
I am Karim.

Stick your photo and say



Hello.  
I am ( say your name )

Learn (a,b)

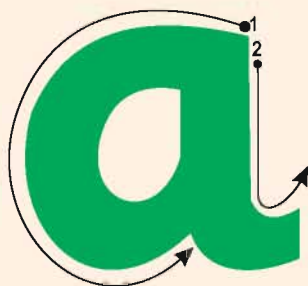

**a**pple

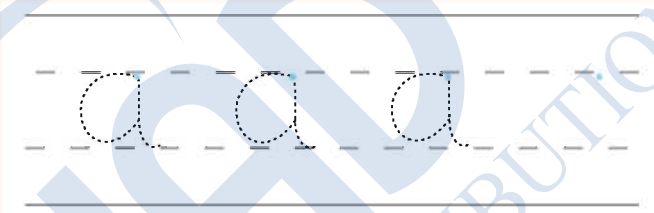
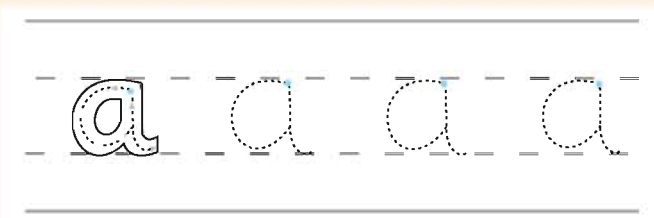

Colour

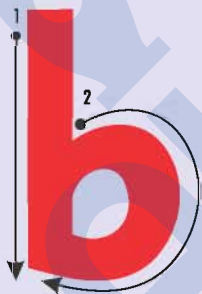
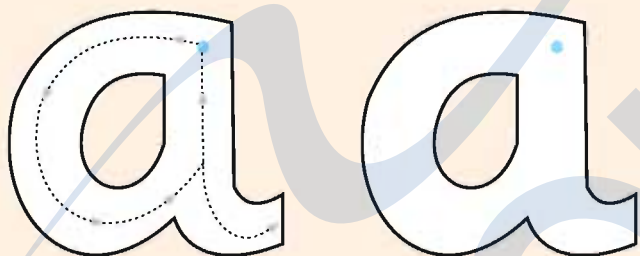

**b**all

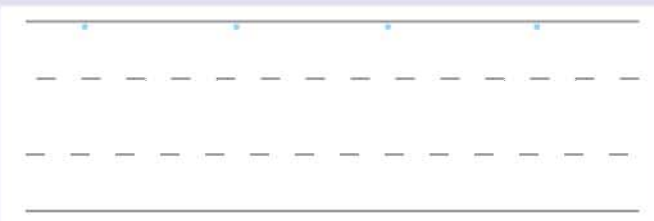
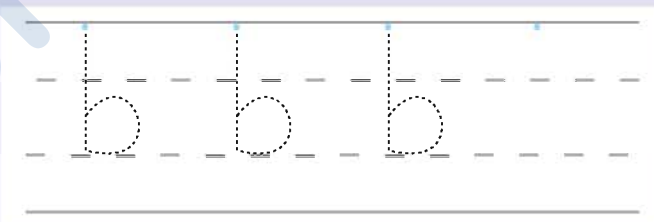
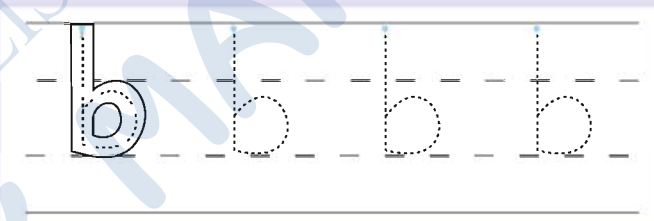

Colour

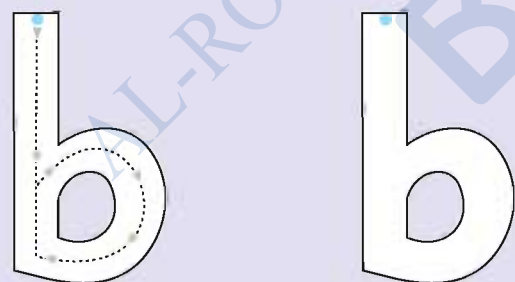

Learn (c,d)



car

Colour

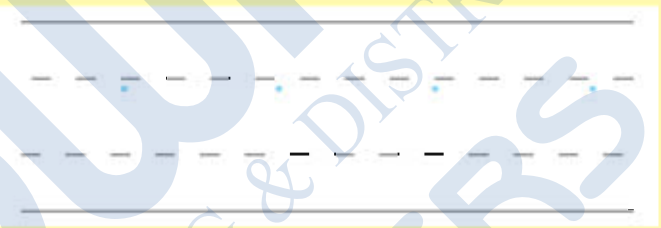
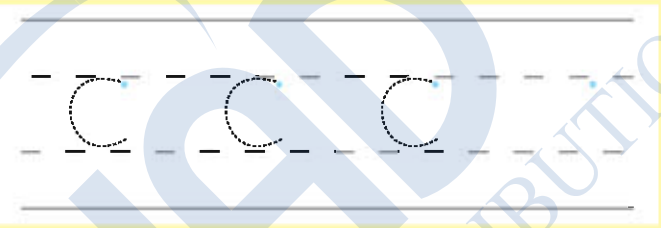
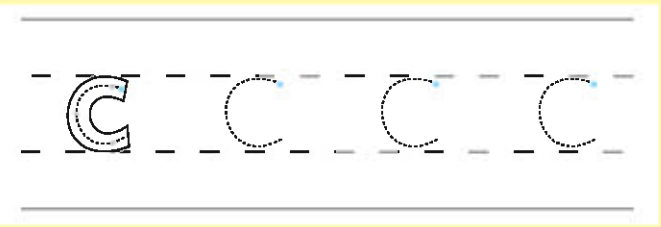
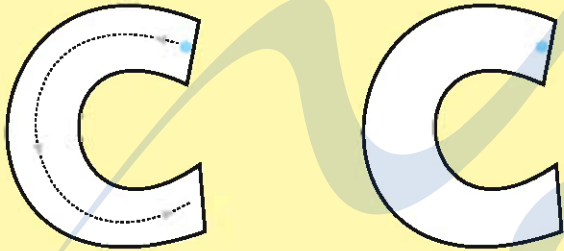

dog

Colour

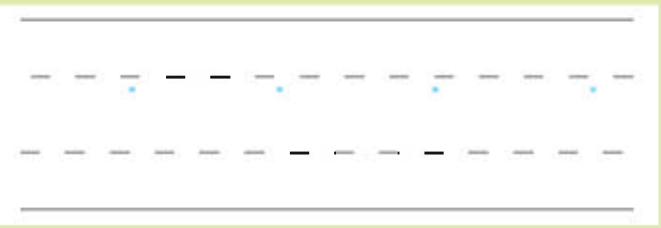
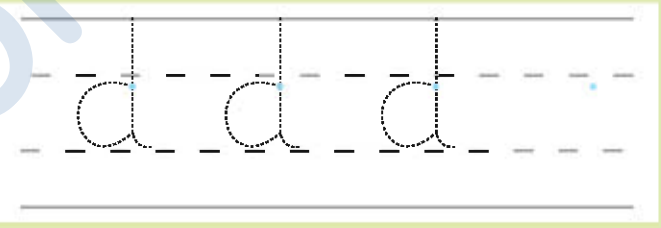
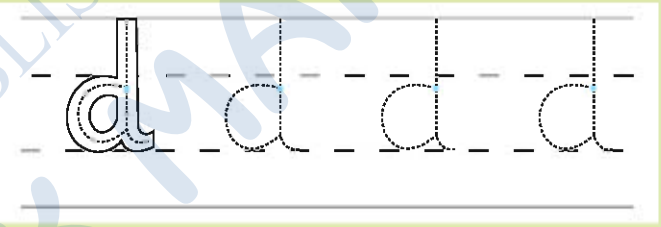
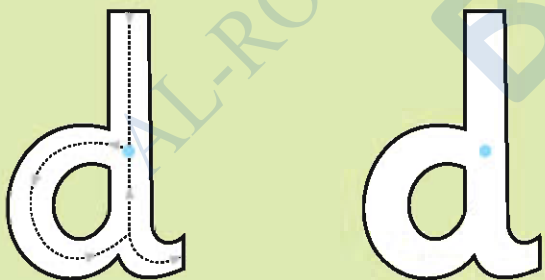



Ask and answer

What colour is it?

blue

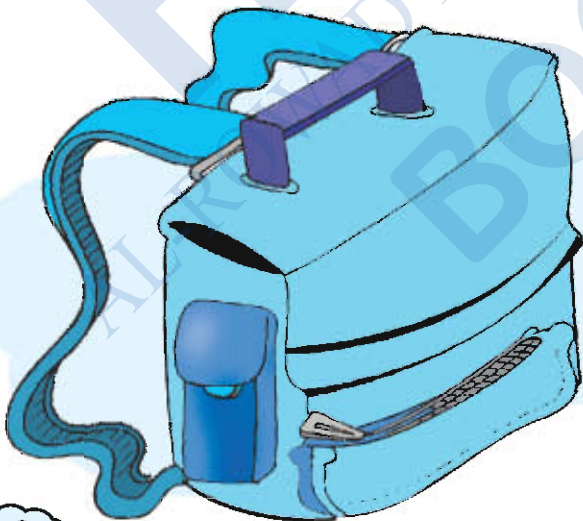
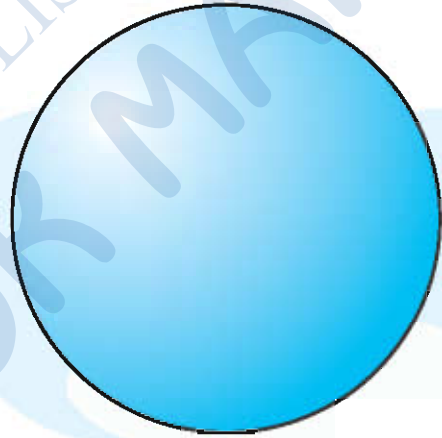

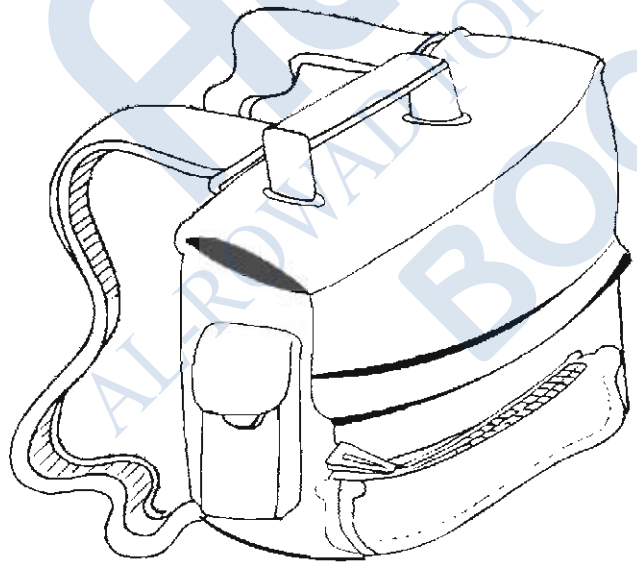
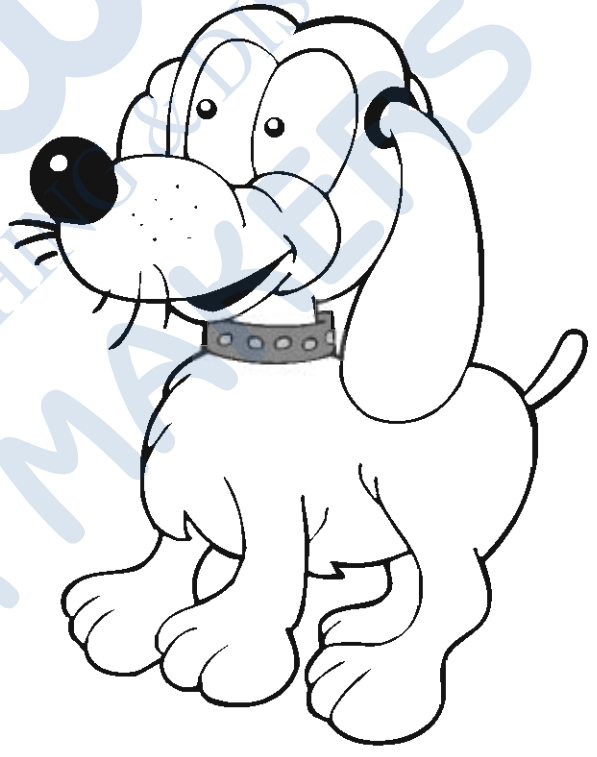
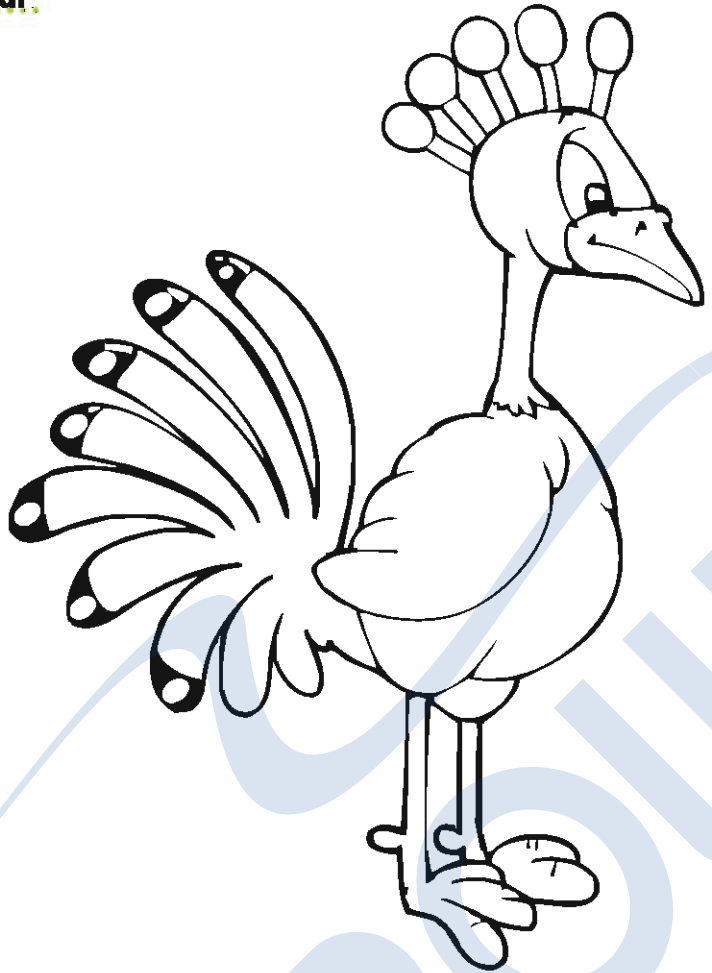

Learn (e, f)

Flash  
card

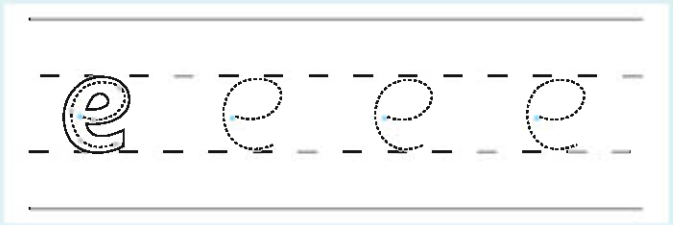
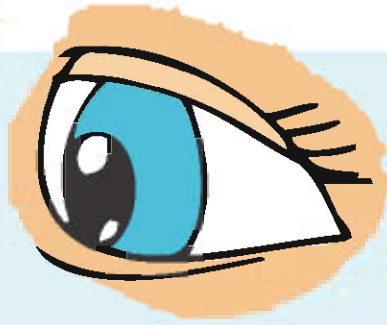

eye



Colour

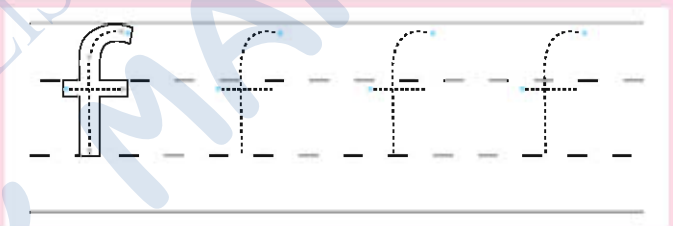
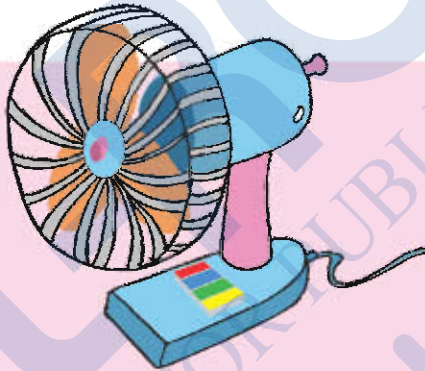
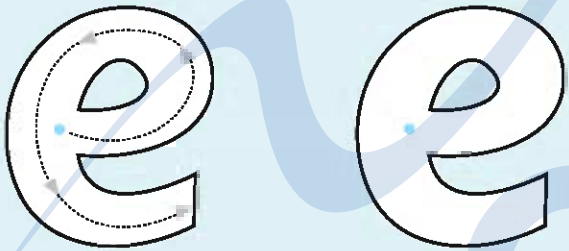

fan

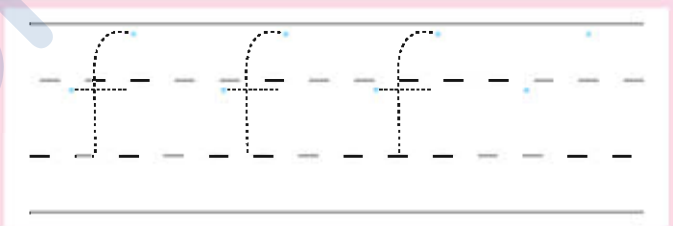

Colour

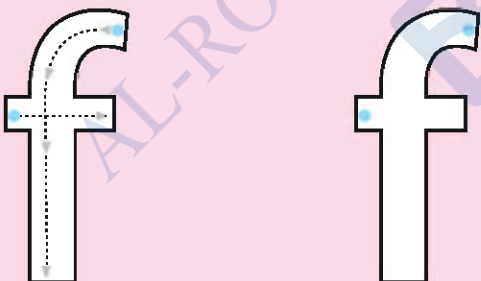

Learn (g,h)

Flash  
card



gift

Colour

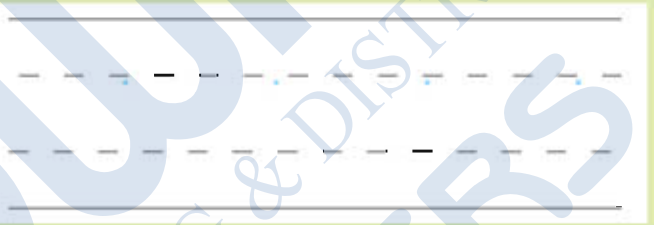
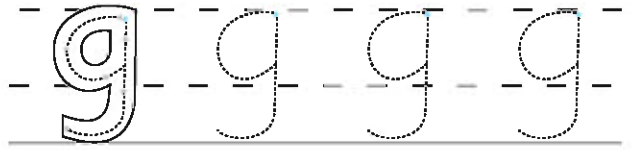
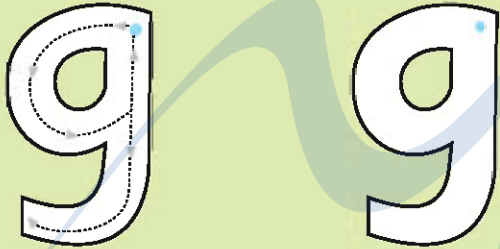

hand

Colour

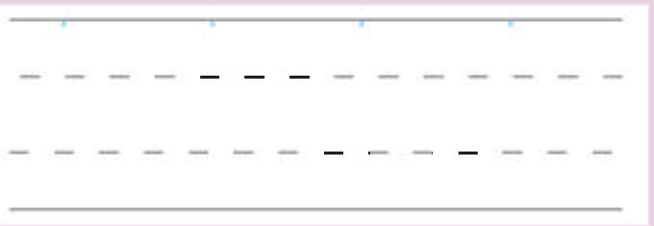
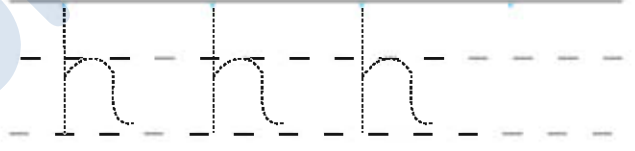
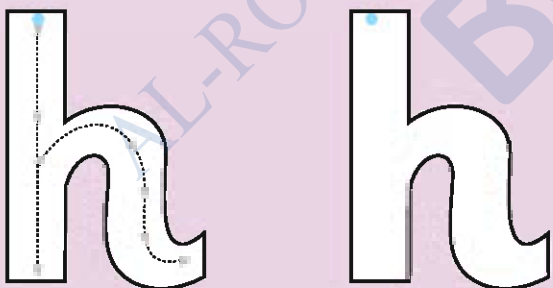

Match the picture on the left to the suitable one on the right.

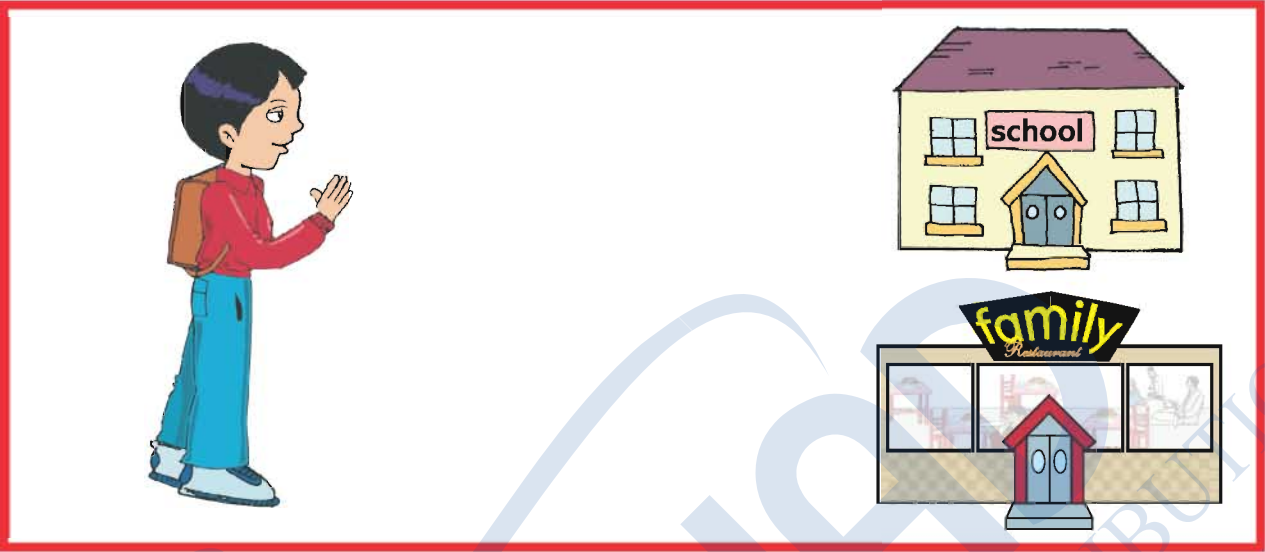

big ... small

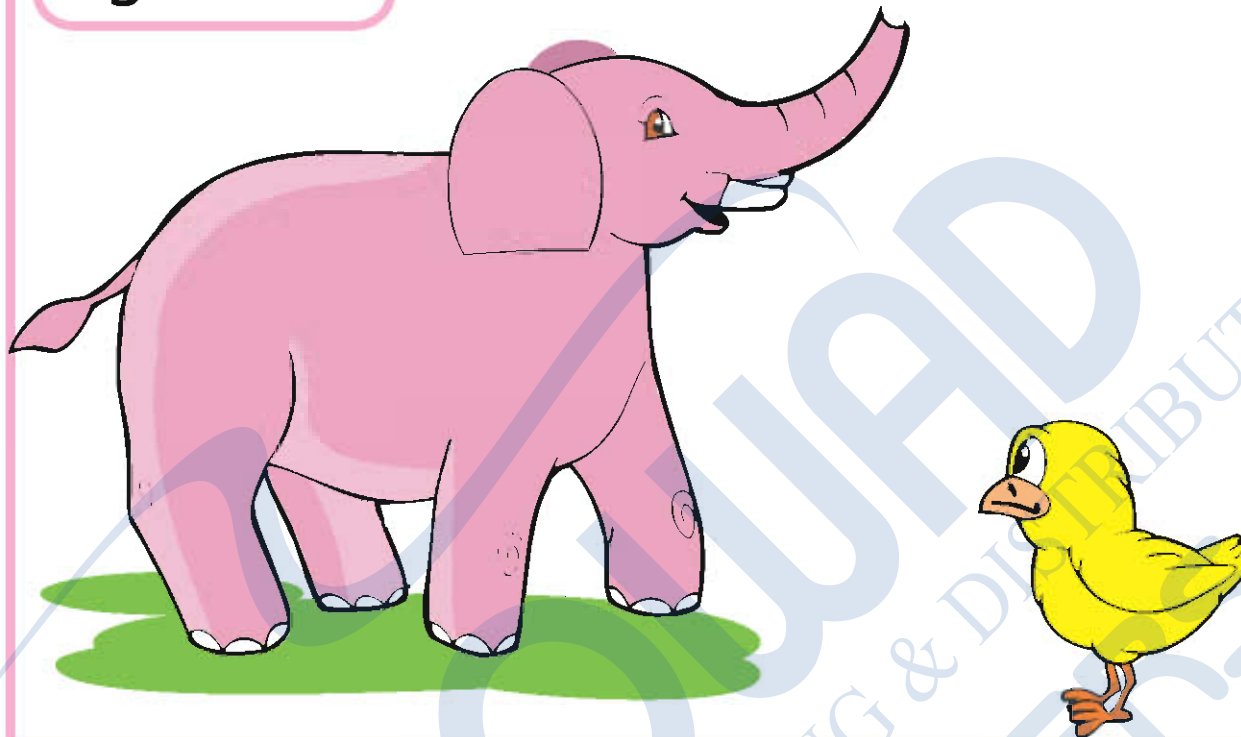

high ... low

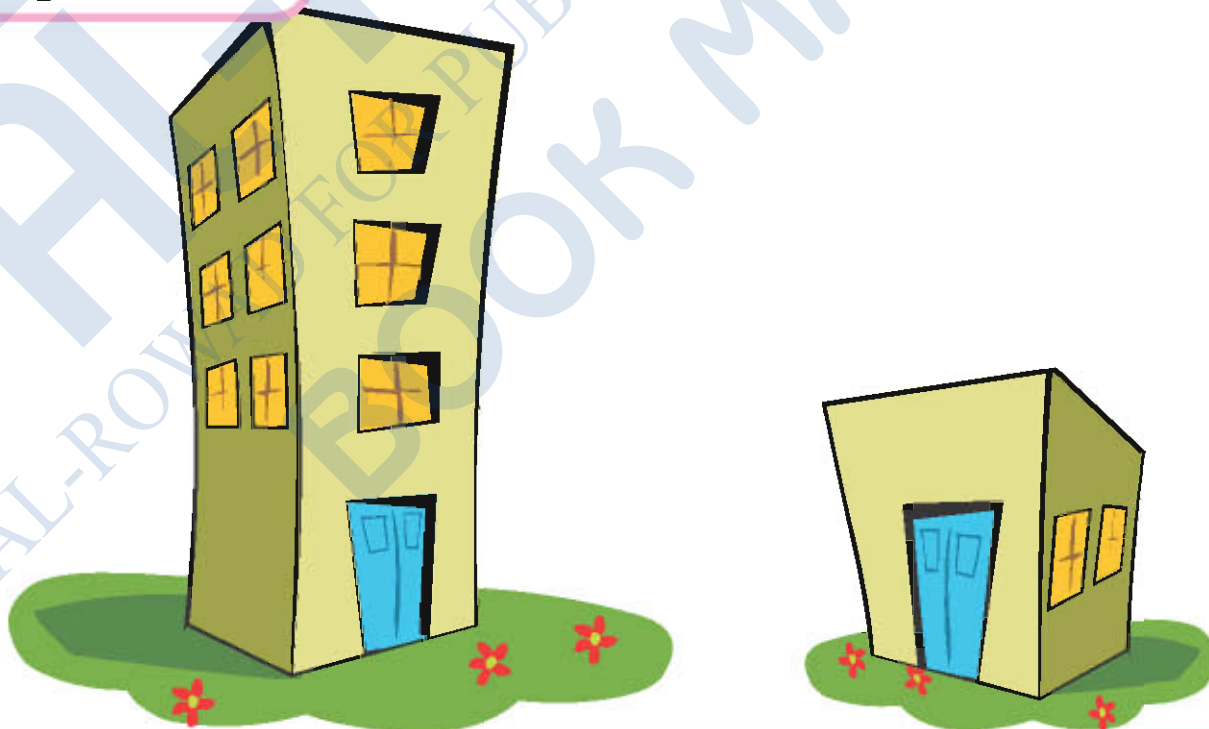

Cross the object that does not belong

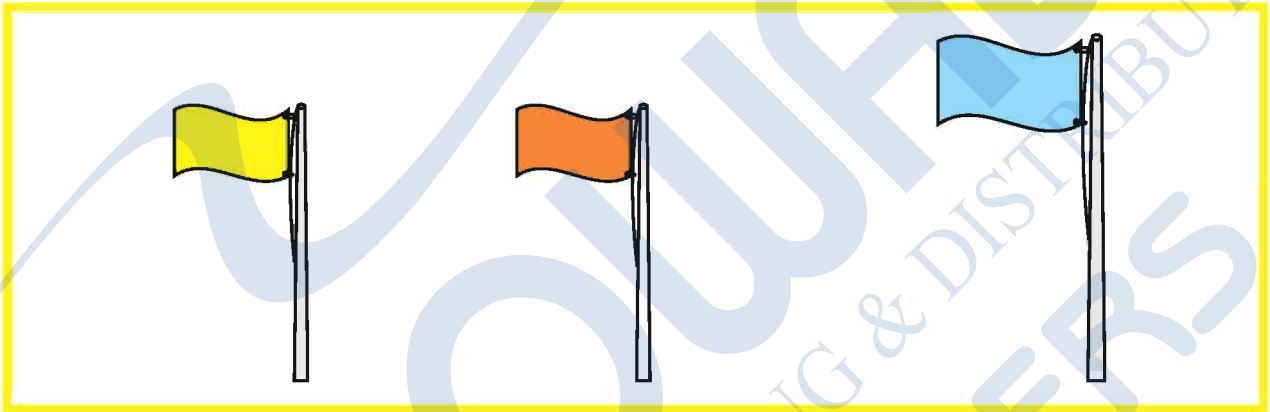

Learn (i, j)

Flash  
card

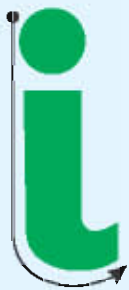

ice-cream

Colour

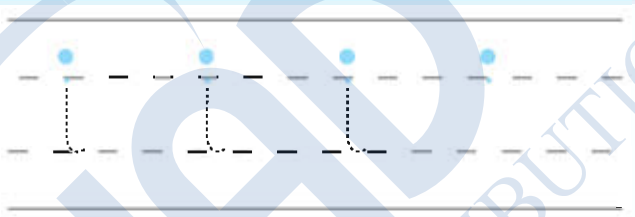
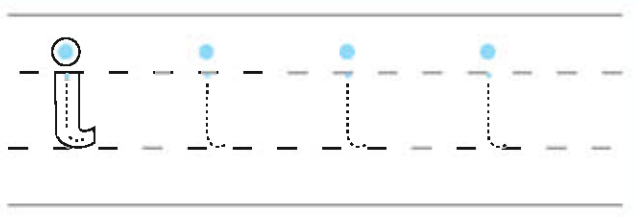
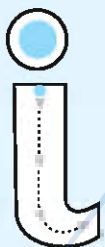

jug

Colour

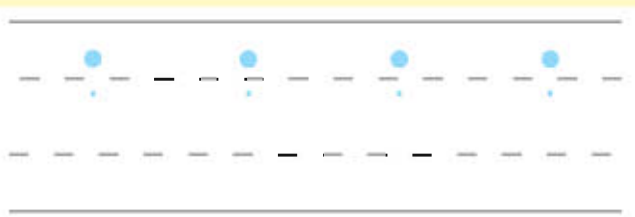
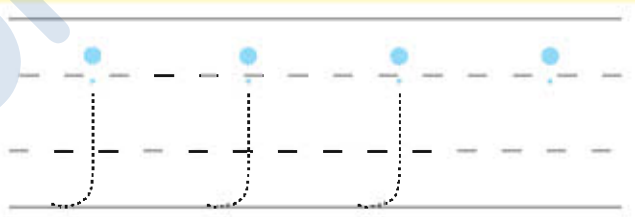
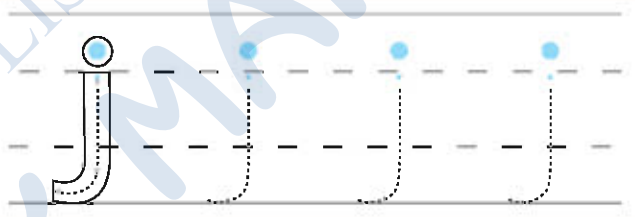
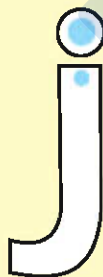
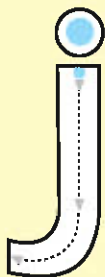



Learn (k,l)

Flash  
card

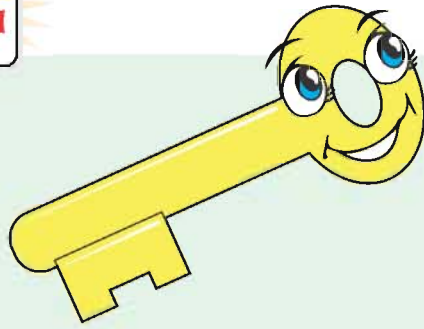
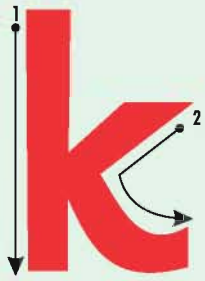

key

Colour

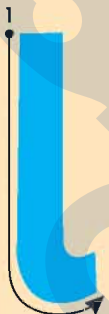
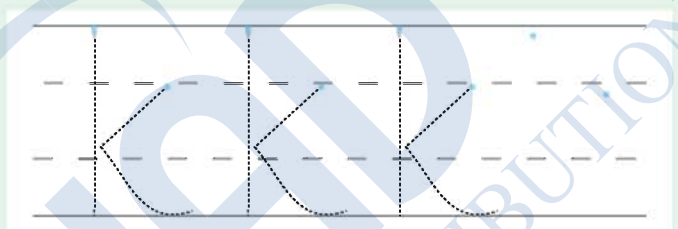
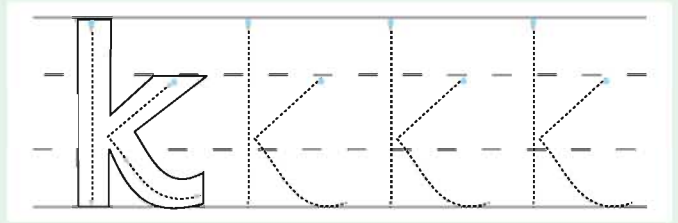
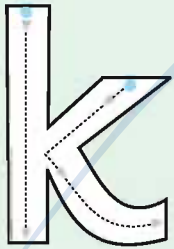

lamp

Colour

