

# New English Splishash 1



**Capital Letter**

*Rasha Al-Shafee*

**AL-RROWAD**  
www.alrowadpub.com

# New English Splash 1

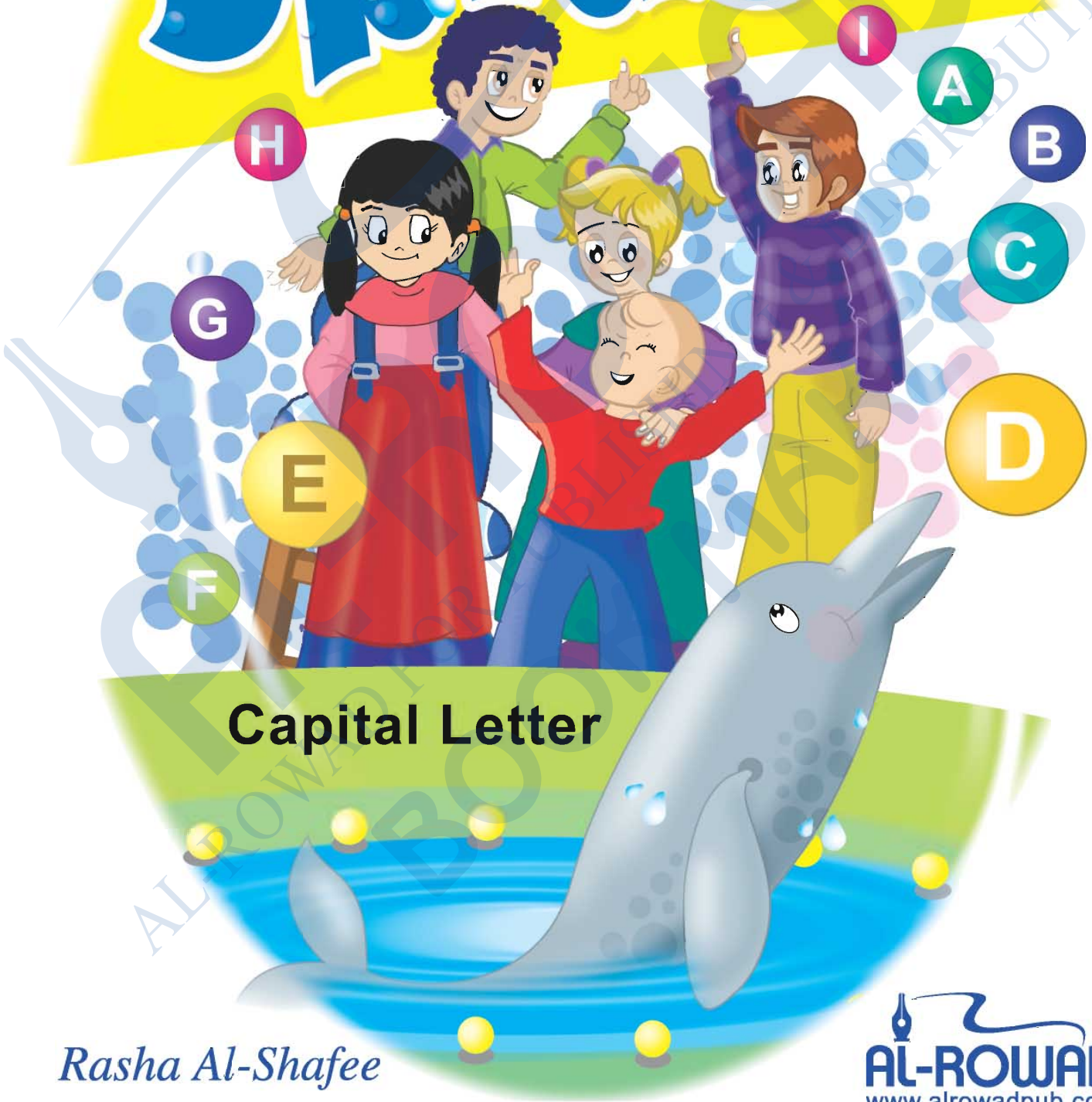

Capital Letter

Rasha Al-Shafee

AL-ROWAD  
www.alrowadpub.com

**ALROWAD** for Publishing & Distribution

Jordan - Amman

Alabdali - Block No. 8

ISBN 978-9957-37-168-5

Text © Mrs. Rasha Alshafee 2010

Design and illustration © **ALROWAD** for Publishing & Distribution

First published 2007

All rights reserved; no part of this publication may be reproduced, stored in a retrieval system, transmitted in any form, or by any means, electronic, mechanical, photocopying, recording, or otherwise, without the prior written permission of the publishers.

Design by Fuad Elayyan      Design officer, **ALROWAD** for Publishing & Distribution  
Amal Hassan      Graphic Design, **ALROWAD** for Publishing & Distribution

Illustrated by Naseem Imteer

Cover design by Fuad Elayyan

Printed and bound in Jordan

2010    2011    2012    2013    2014

Photo

Name: .....

Class: .....

School: .....





Hello , hello.



How are you?

How are you?

I'm fine thank you.



I'm fine to see you.

How do you do? How do you do?

So nice to meet you.

So nice to meet you.

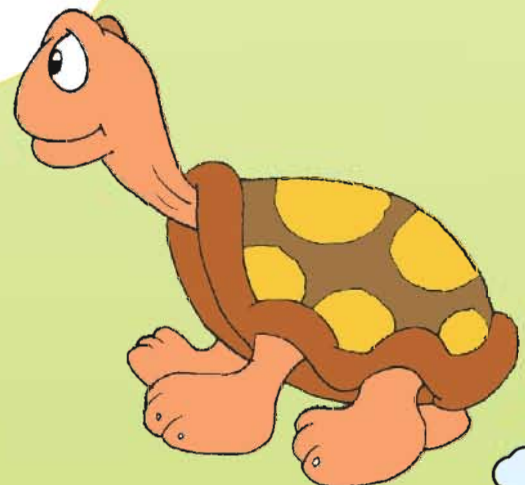

Hello.

Hello.  
I am Laila.

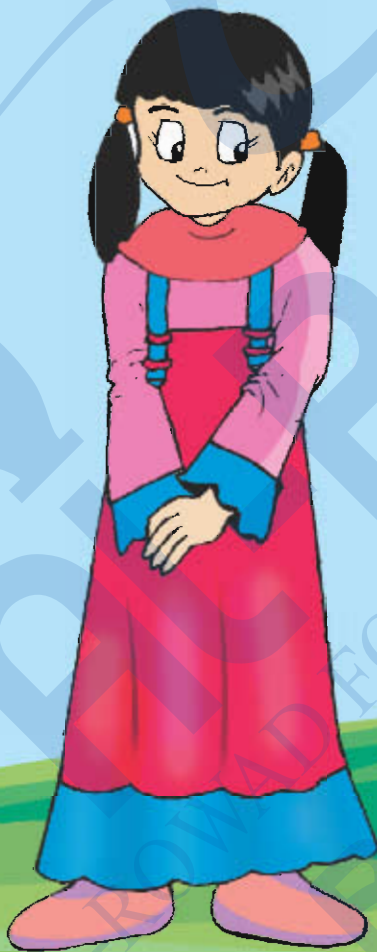

Hello.  
I am Salama





Hello.  
I am Karim.

Stick your photo and say

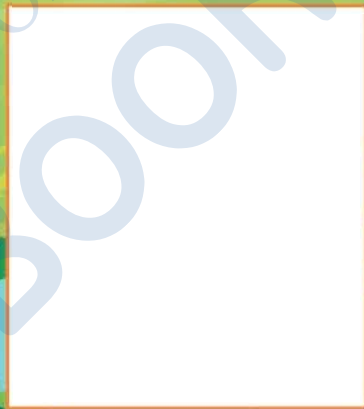

Hello.  
I am ( say your name )

Learn (A,B)



**APPLE**

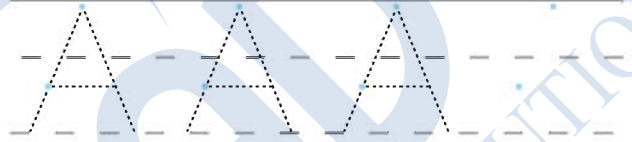
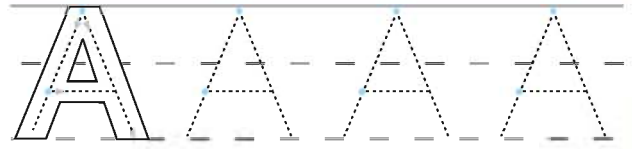
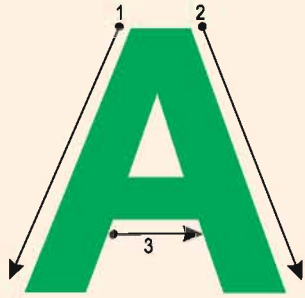

Colour

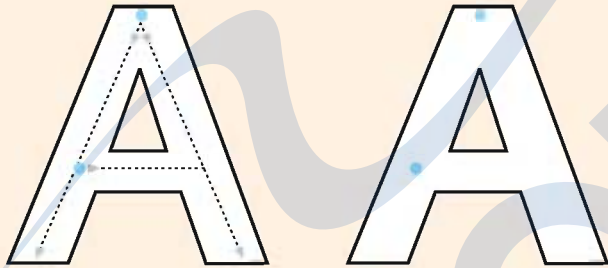

**BALL**

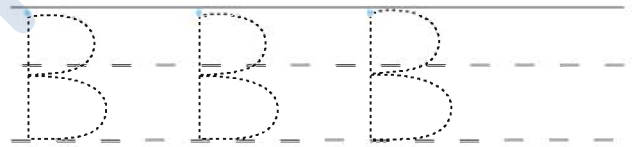
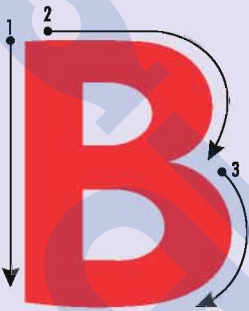

Colour

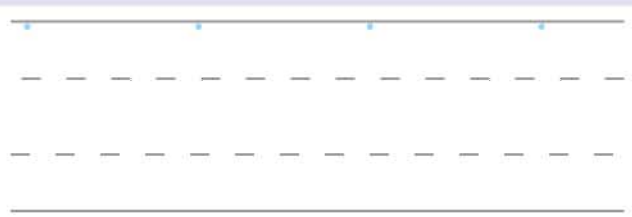
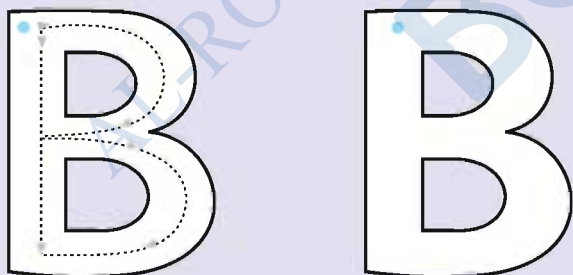

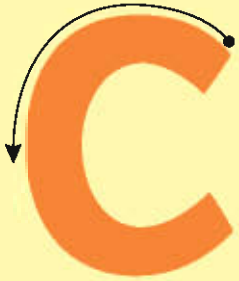

CAR

Colour

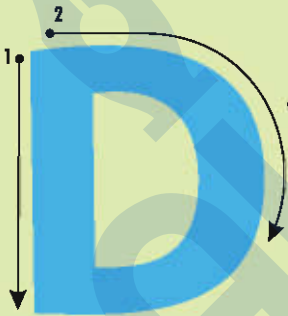
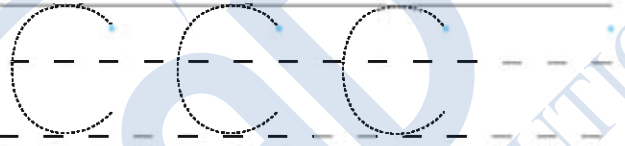
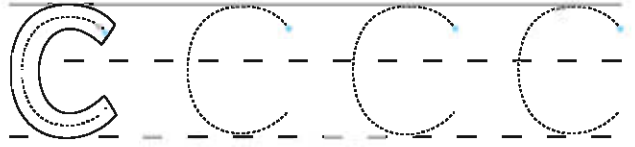
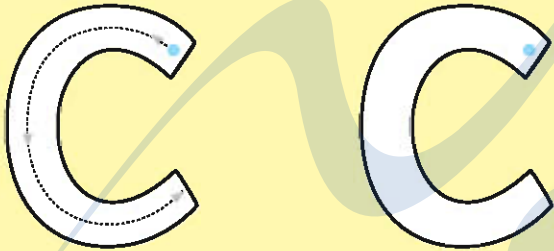

DOG

Colour

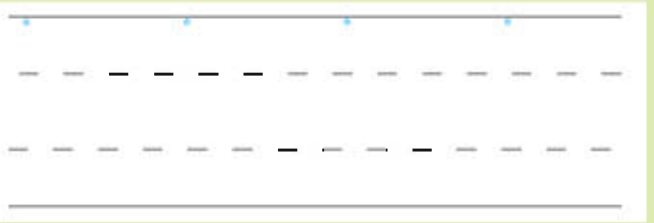
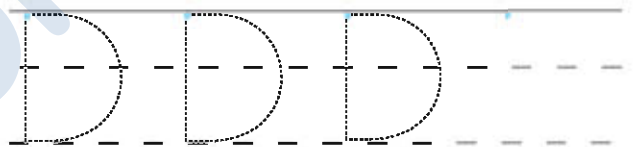
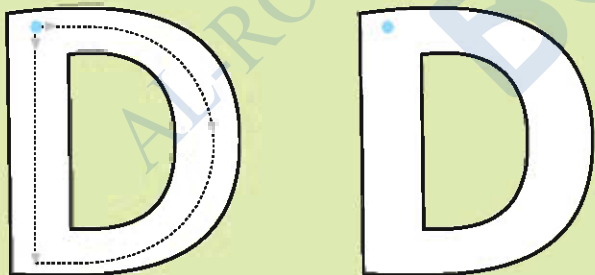



Ask and answer  
What colour is it?

# Blue

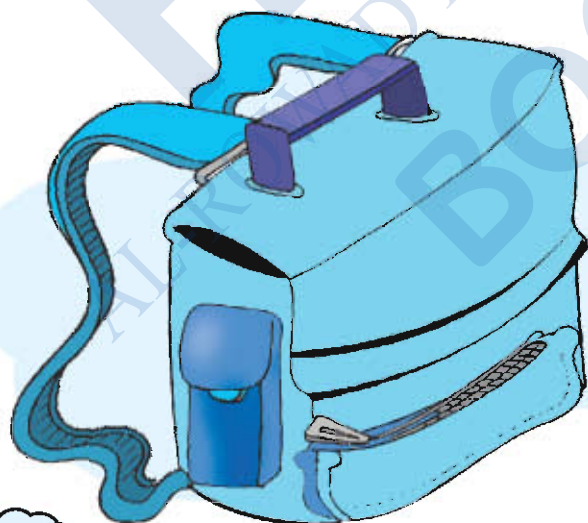
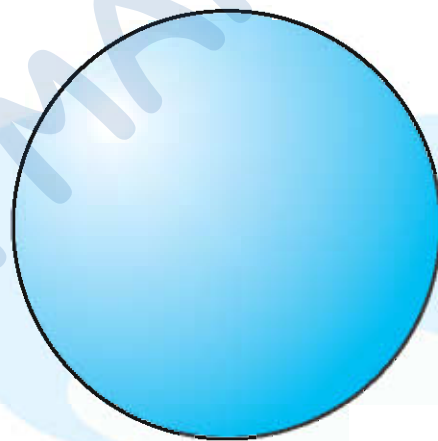

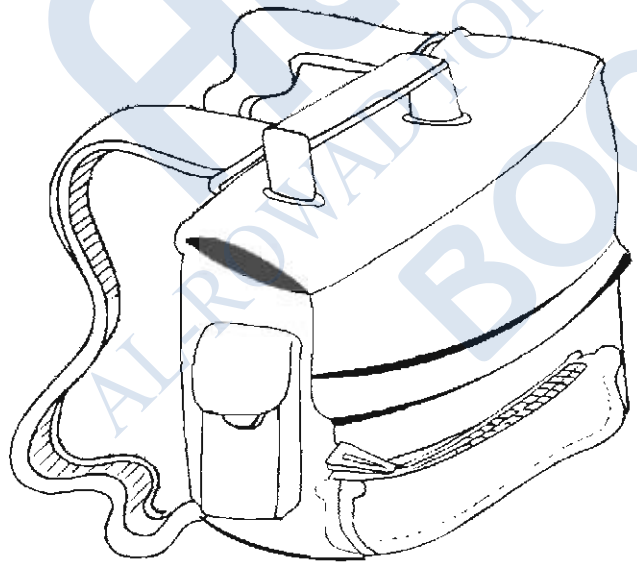
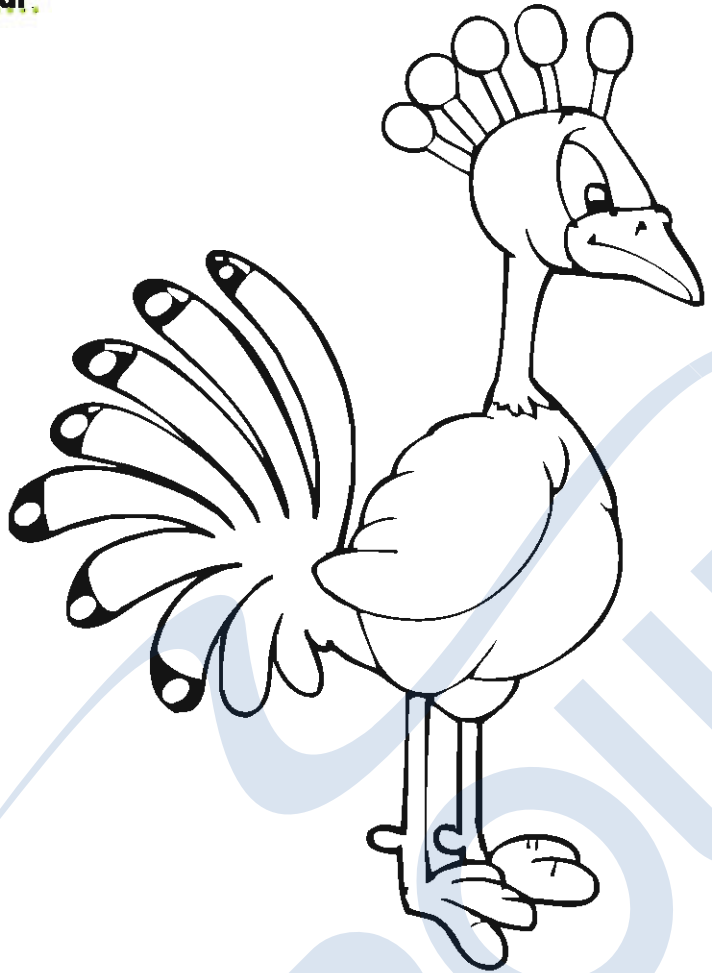

Learn ( F,E)

Flash  
card

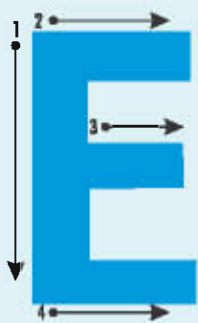
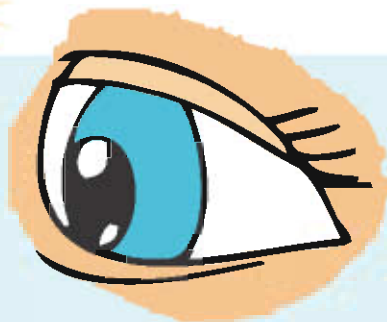

**EYE**

Colour

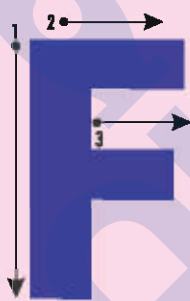
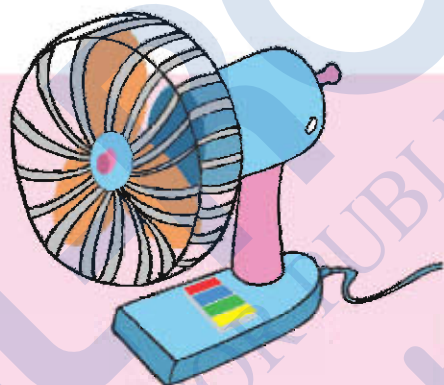
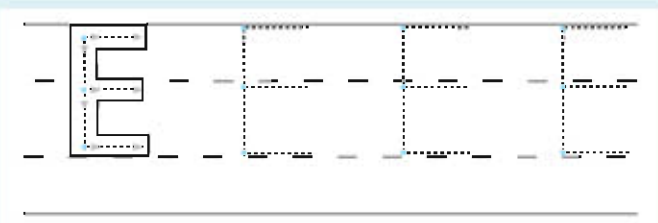
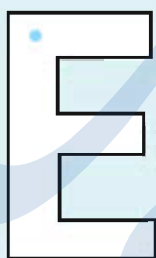
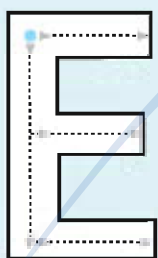

**FAN**

Colour

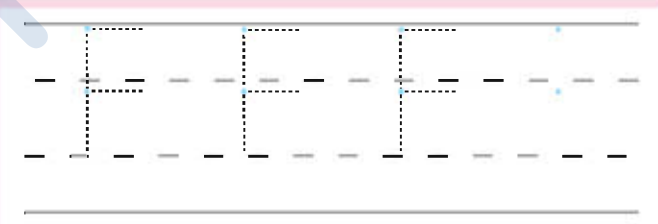
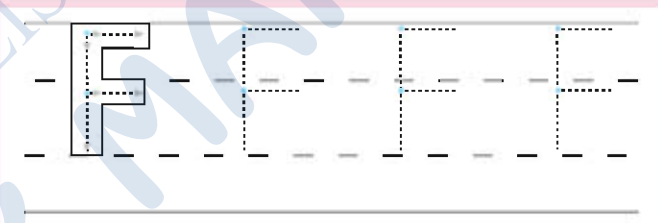
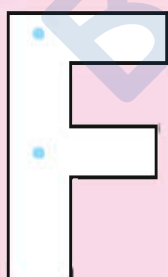
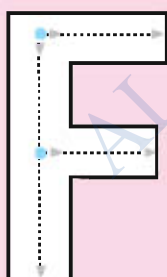

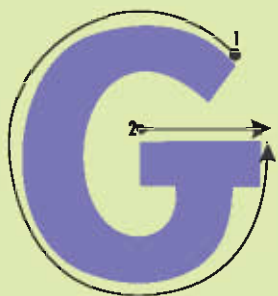

**GIFT**

Colour

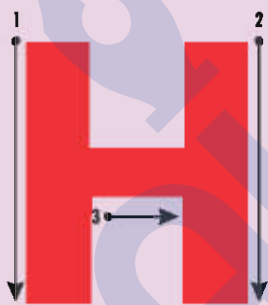
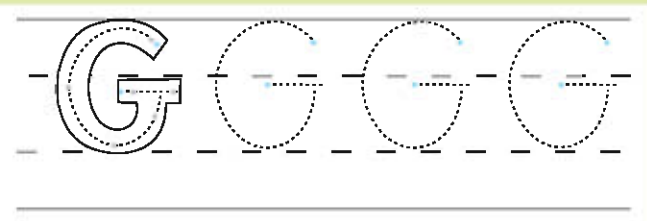
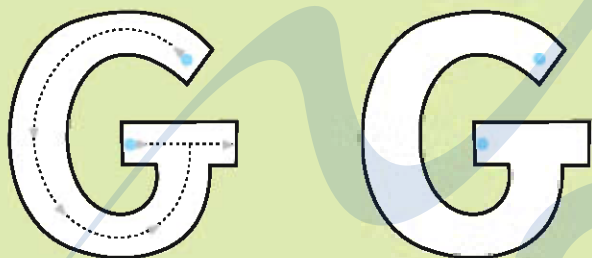

**HAND**

Colour

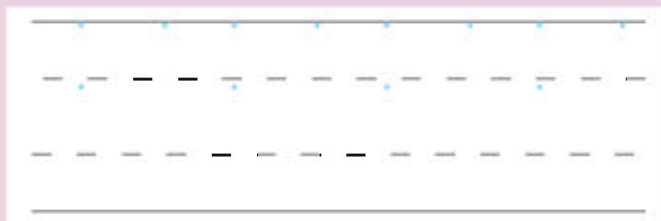
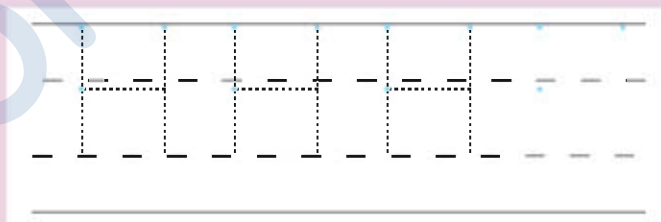
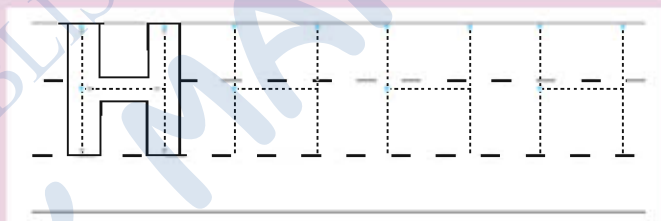
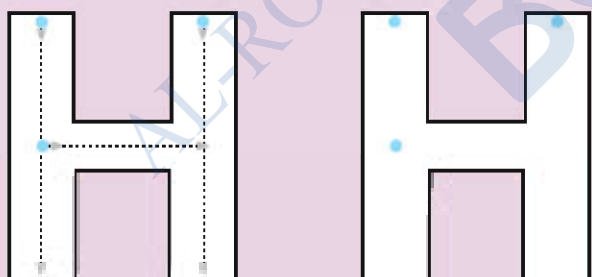

Match the picture on the left to the suitable one on the right

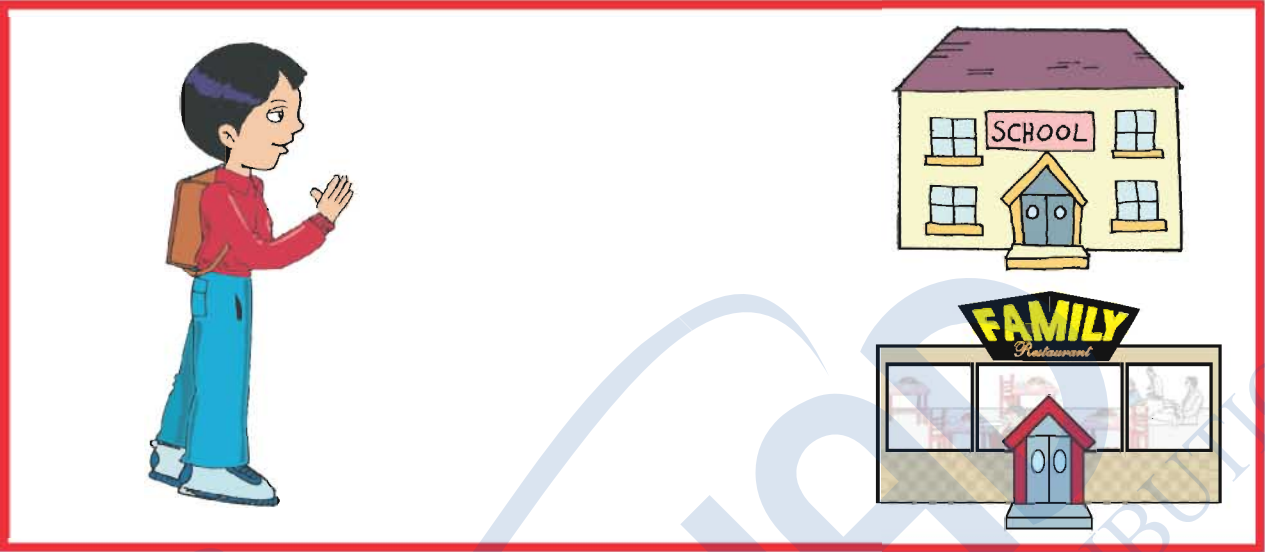

Big ... Small

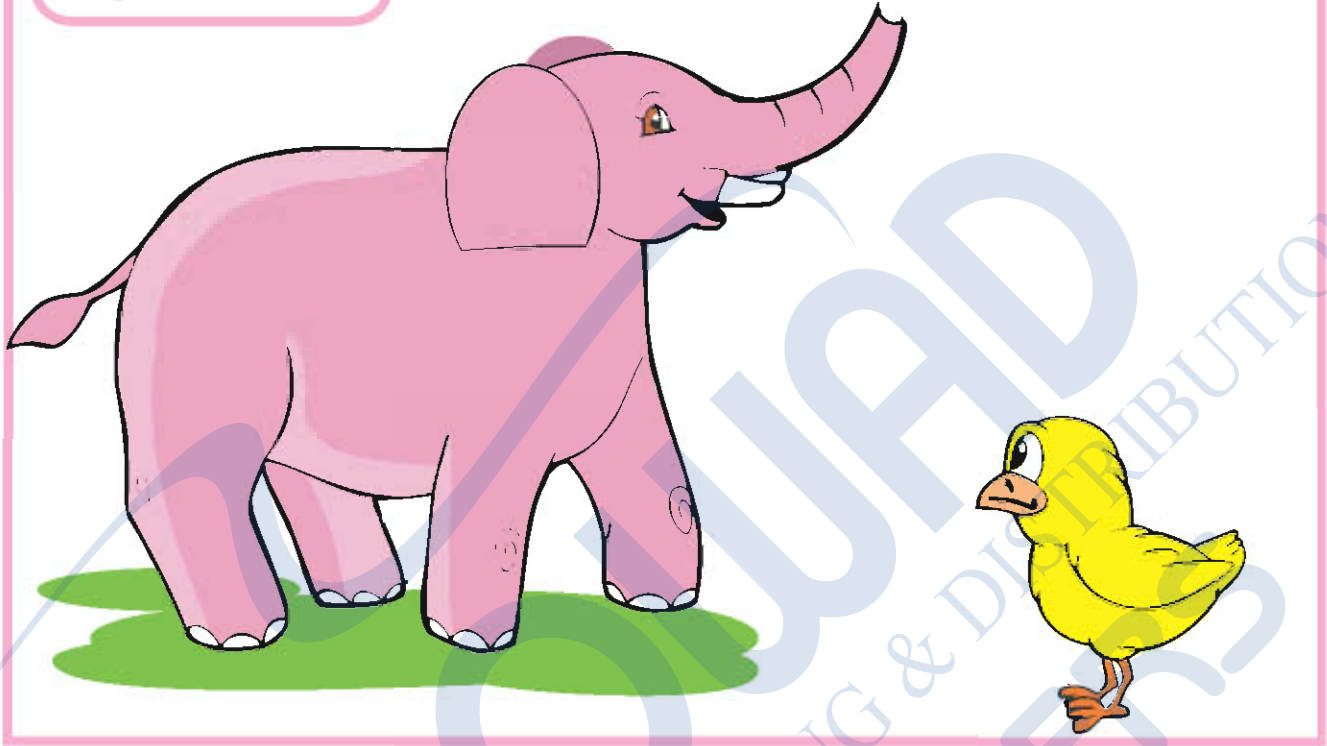

High ... Low

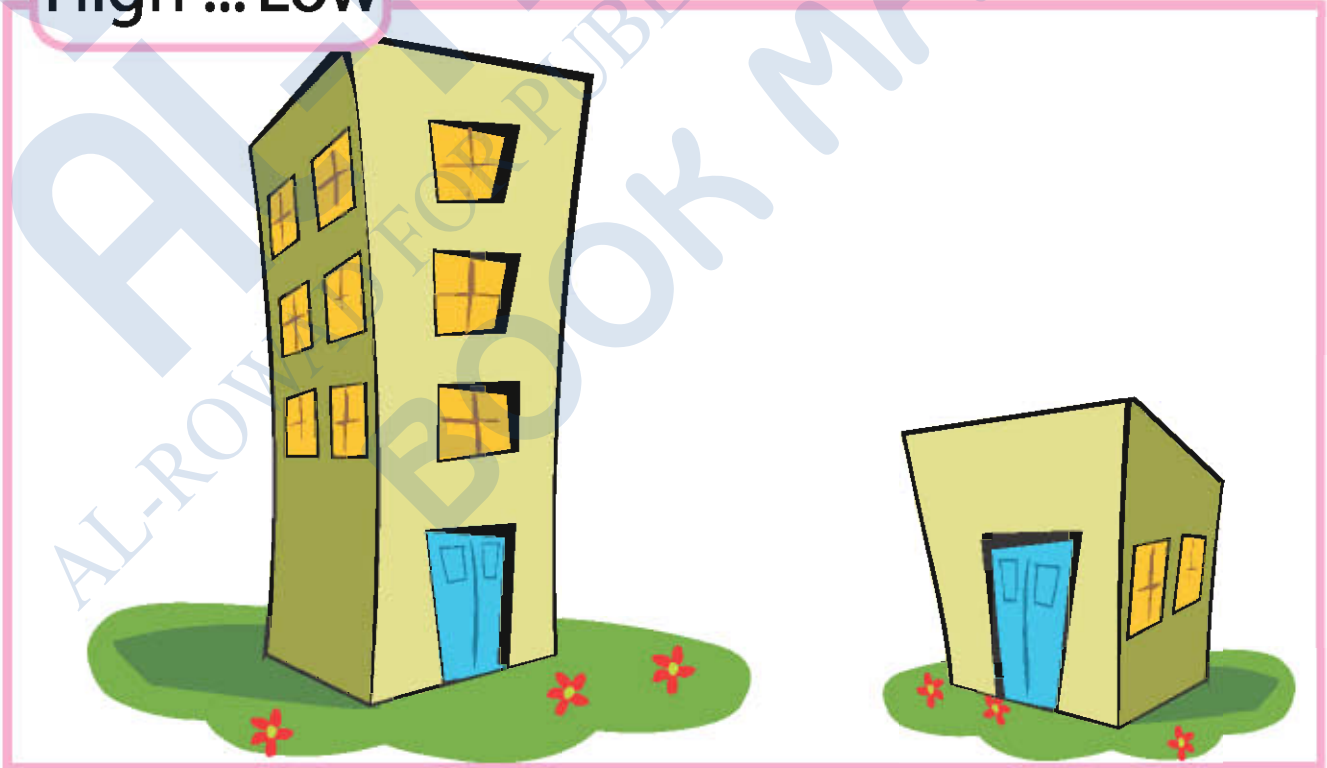

Cross the object that does not belong.

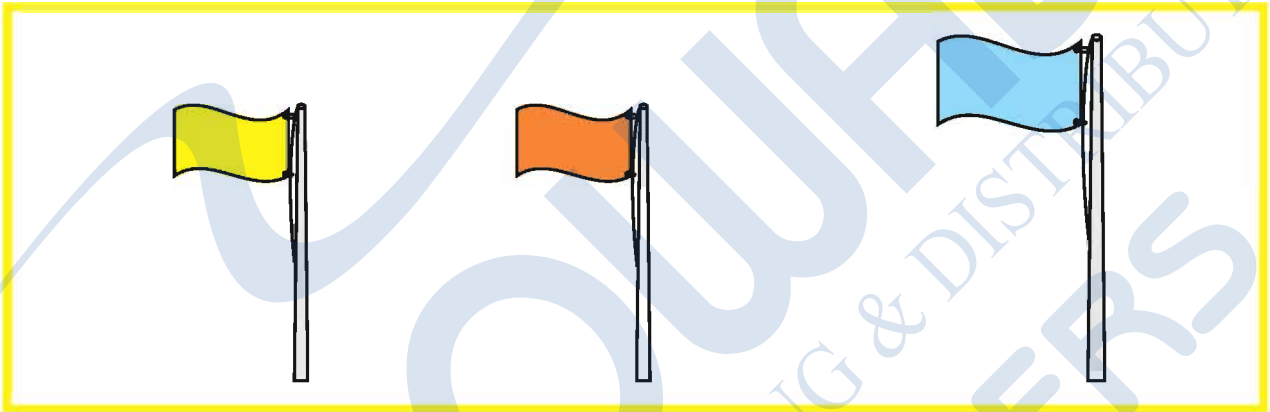

Learn (I,J)

Flash  
card

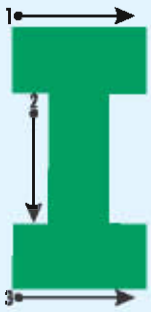

**ICE-CREAM**

Colour

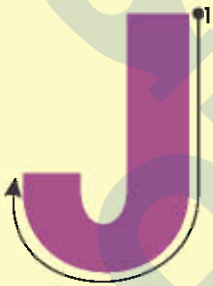
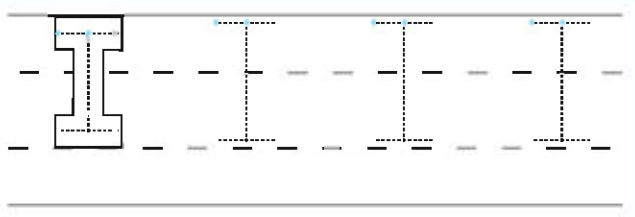
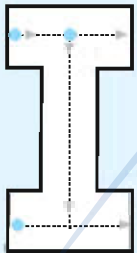

**JUG**

Colour

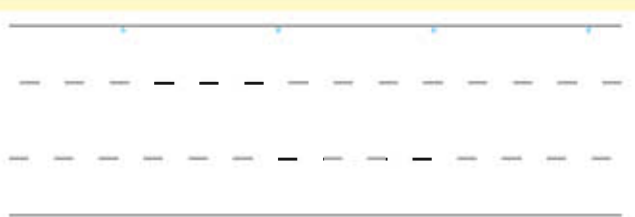
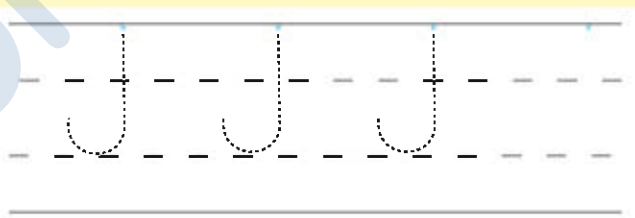
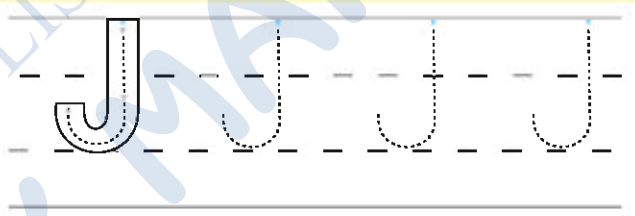
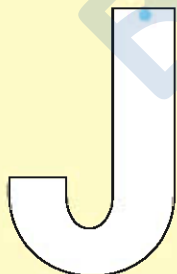
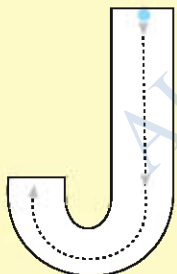



Learn (k,l)

Flash  
card

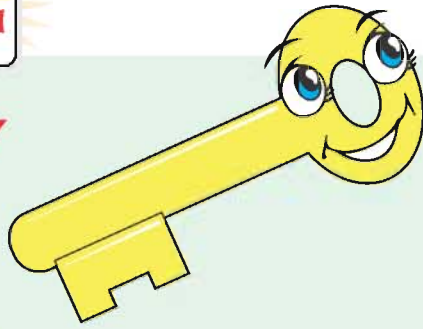
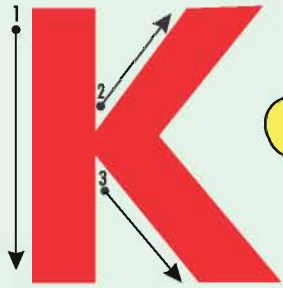

**KEY**

Colour

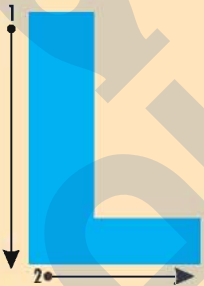
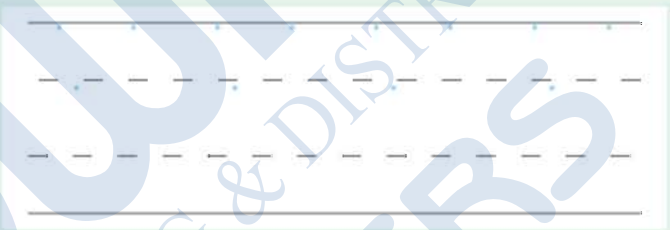
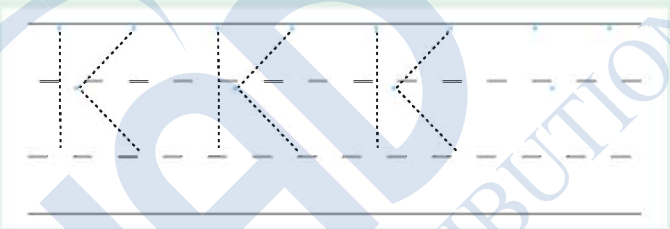
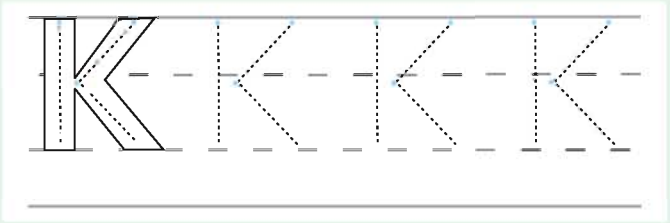
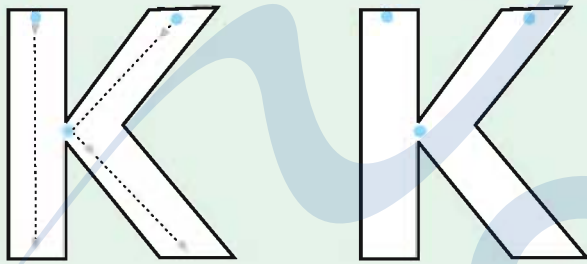

**LAMP**

Colour

