

English Splash 2



Activity Book

Rasha Al-Shafee

AL-ROWAD
www.alrowadpub.com

English Splash 2

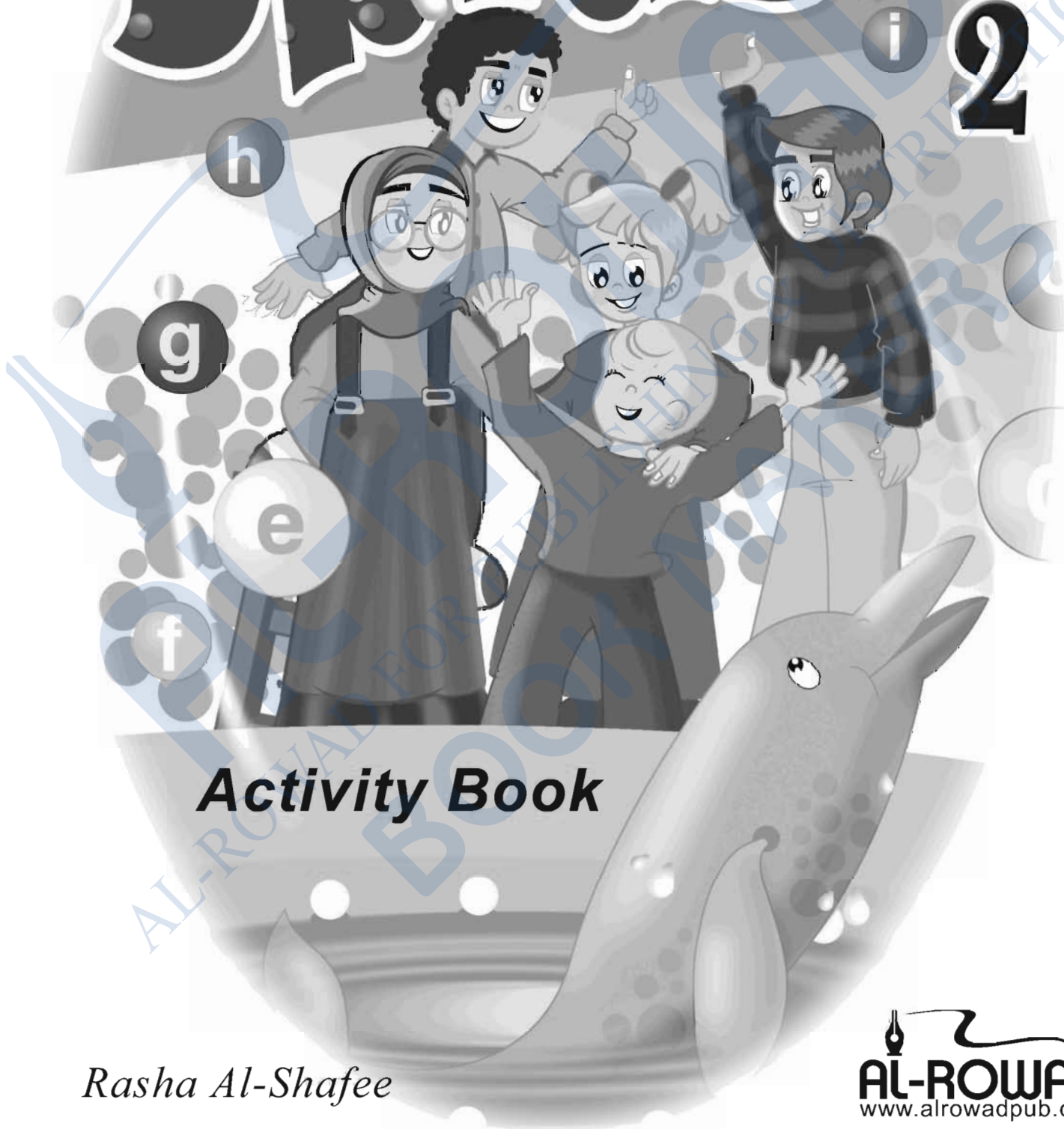

Activity Book

Rasha Al-Shafee

AL-RROWAD
www.alrowadpub.com

ALROWAD for Publishing & Distribution
Jordan - Amman
Alabdali - Block No. 8

ISBN 978-9957-37-156-2

Text © Rasha Al-Shafee 2008
Design and illustration © **ALROWAD** for Publishing & Distribution

First published 2008

All rights reserved; no part of this publication may be reproduced, stored in a retrieval system, transmitted in any form, or by any means, electronic, mechanical, photocopying, recording, or otherwise, without the prior written permission of the publishers.

Design by Ahmad Salem Design officer, **ALROWAD** for Publishing & Distribution

Illustrated by Naseem Mteer
Cover design by Fuad Elayyan

Printed and bound in Jordan
2008 2009 2010 2011 2012

Central Press-Jordan



Name:

Class:

School:



Welcome

Stick your picture here.

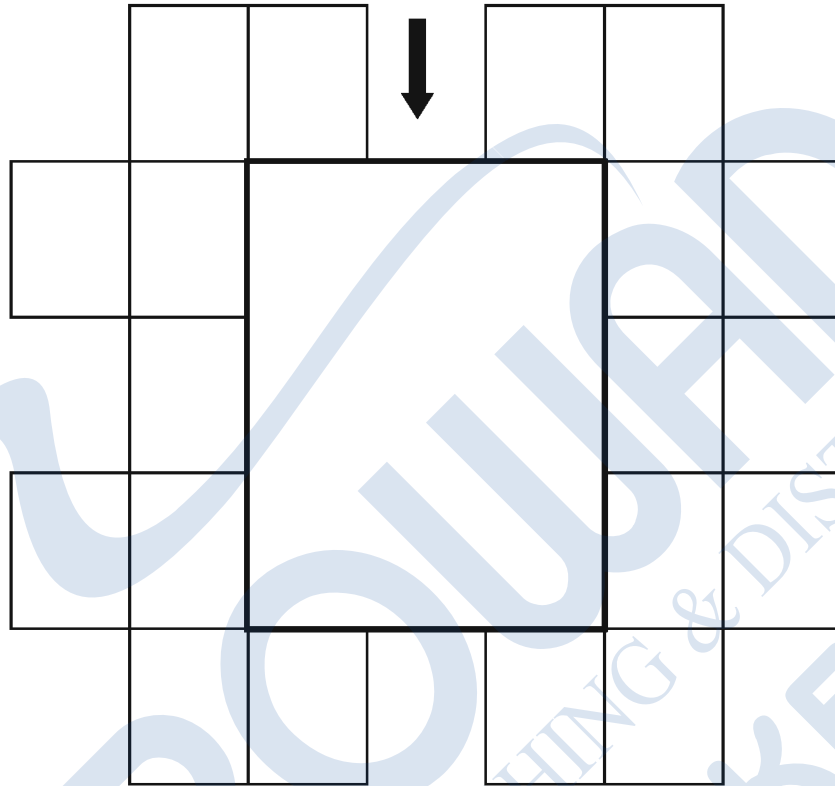

This is my

father

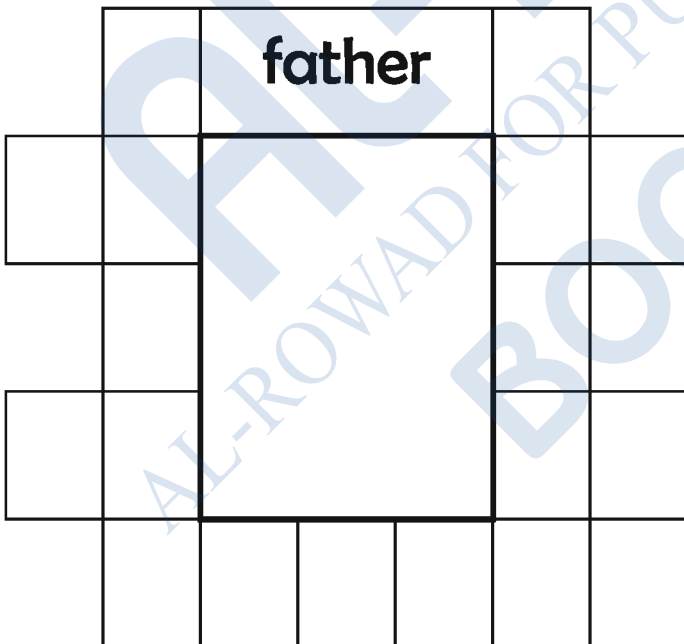

This is my

mother

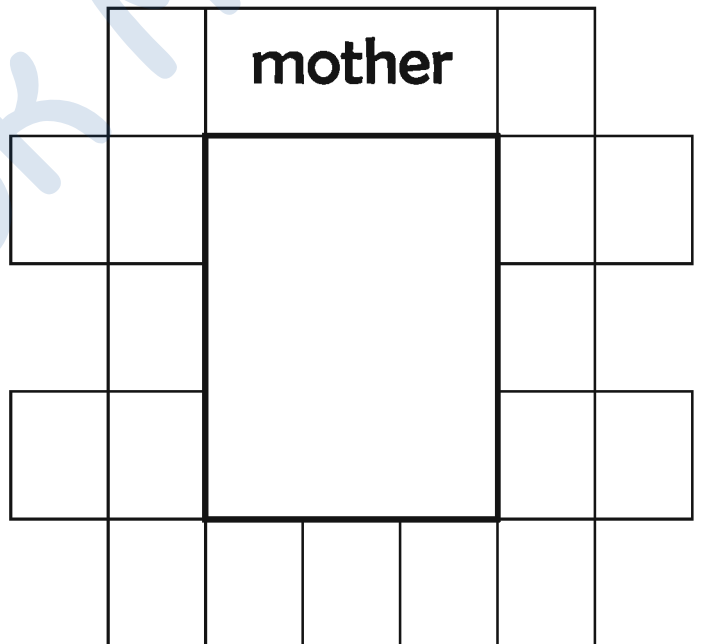

Match the action word to the suitable picture.

Bring me



Go to your desk

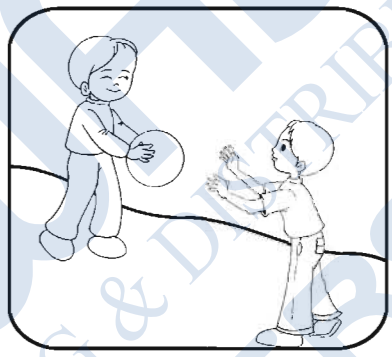

Come here

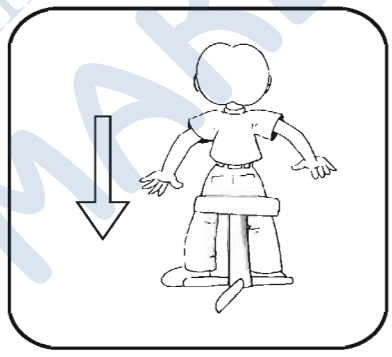

Sit down



Write:

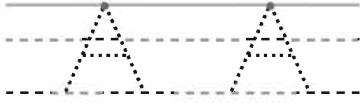
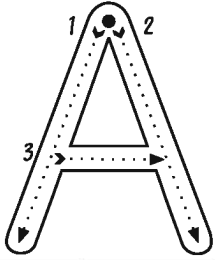
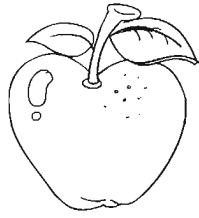

apple

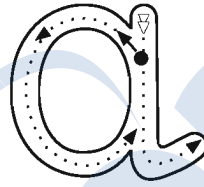

Write:

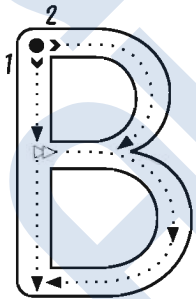
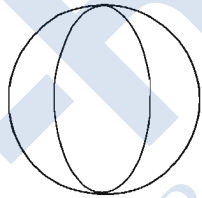

ball

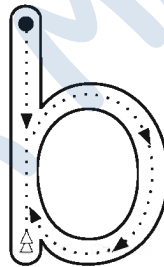

Write:

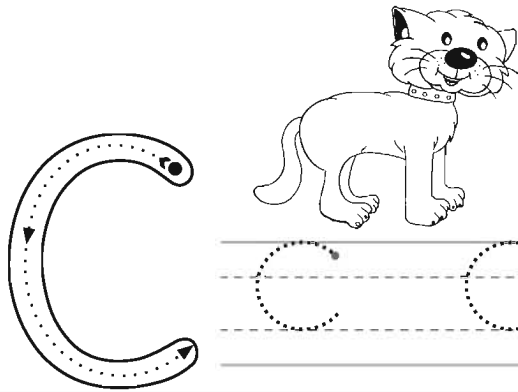

cat

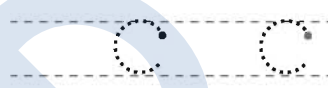

Write:

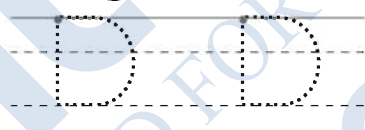
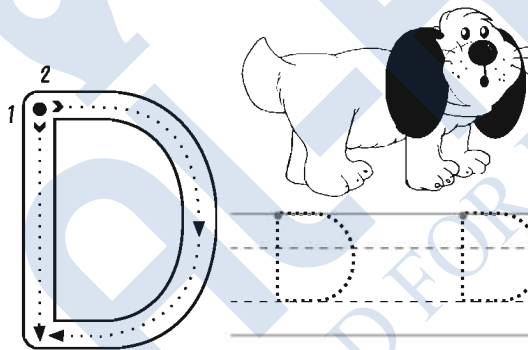

dog

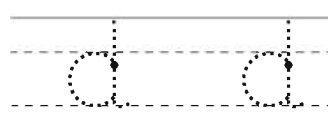
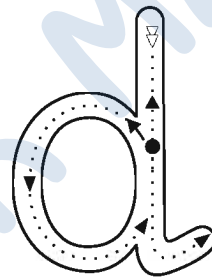

Write:

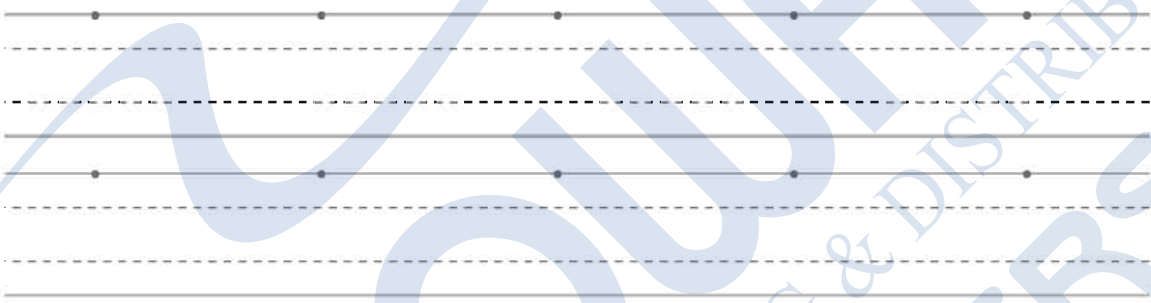
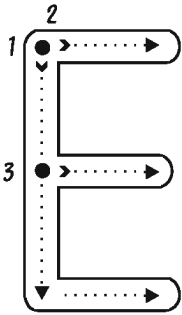

egg

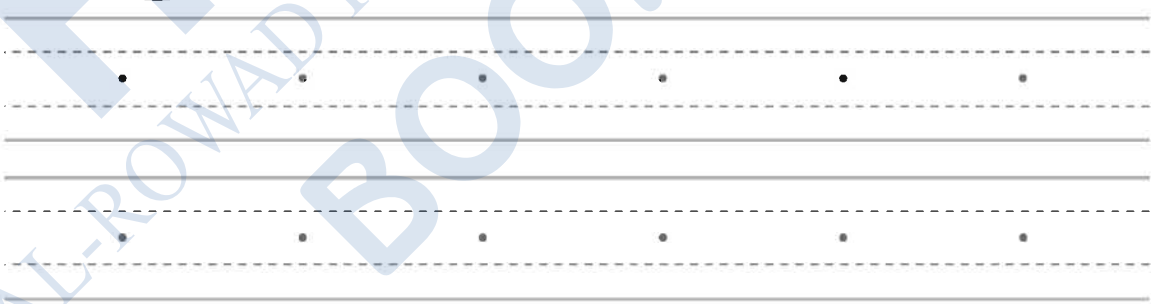

Say and join.

Bb

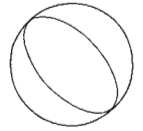

Cc



Ee



Aa



Dd

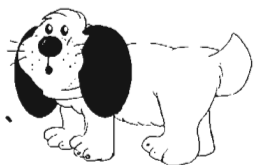

Circle the odd one out.

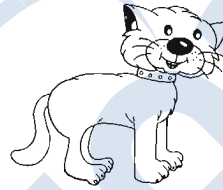
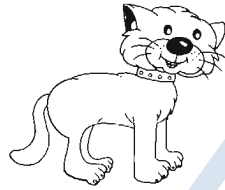
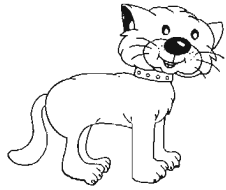
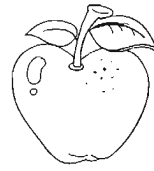
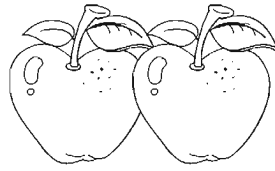
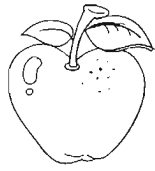

Ee

Cc

Cc

Cc

Find, join and say

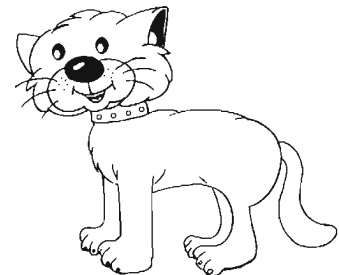
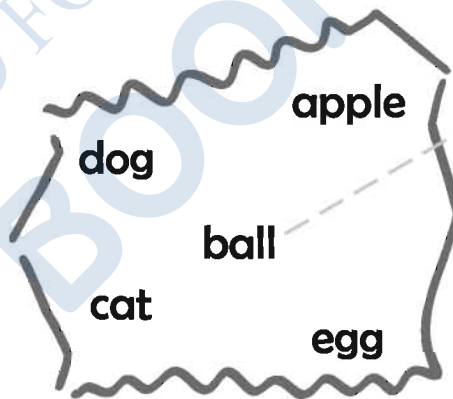
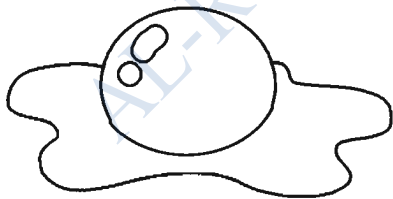
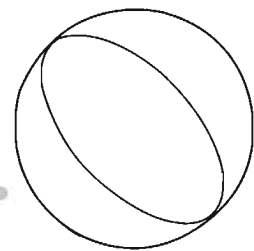
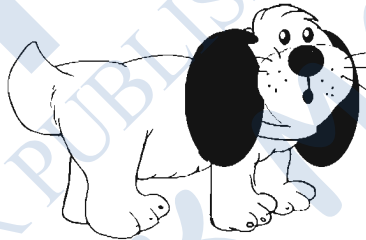

Greetings

Say and Match

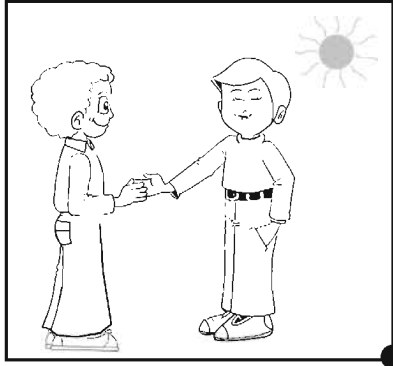

• Good morning

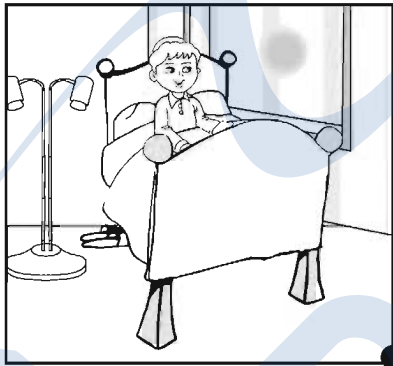

• Good afternoon

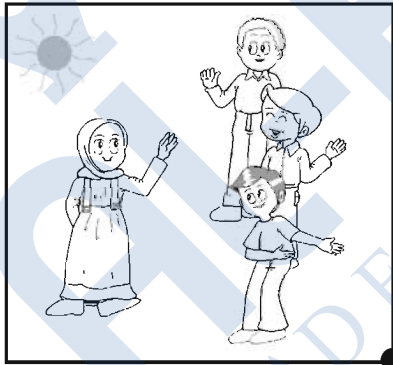

• Good night

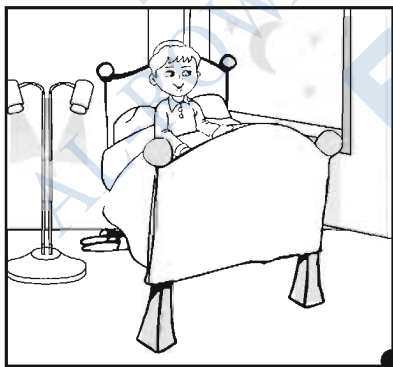

• Good evening

Colour the object that has a relative with.

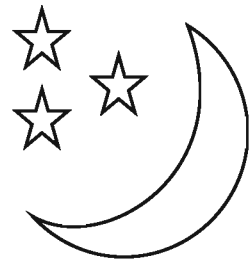
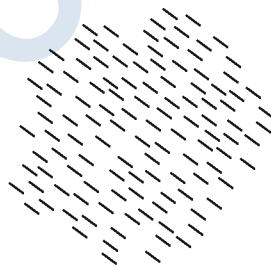
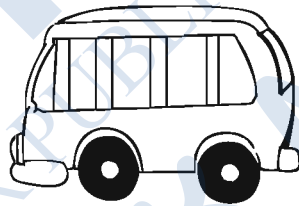
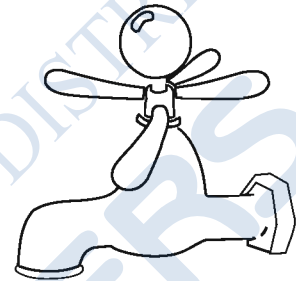
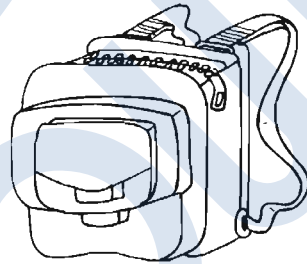
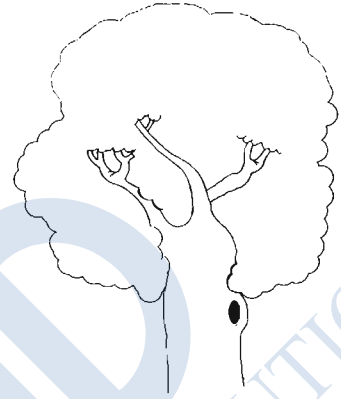
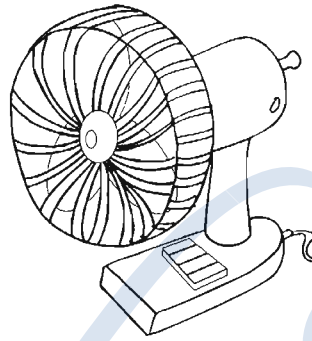
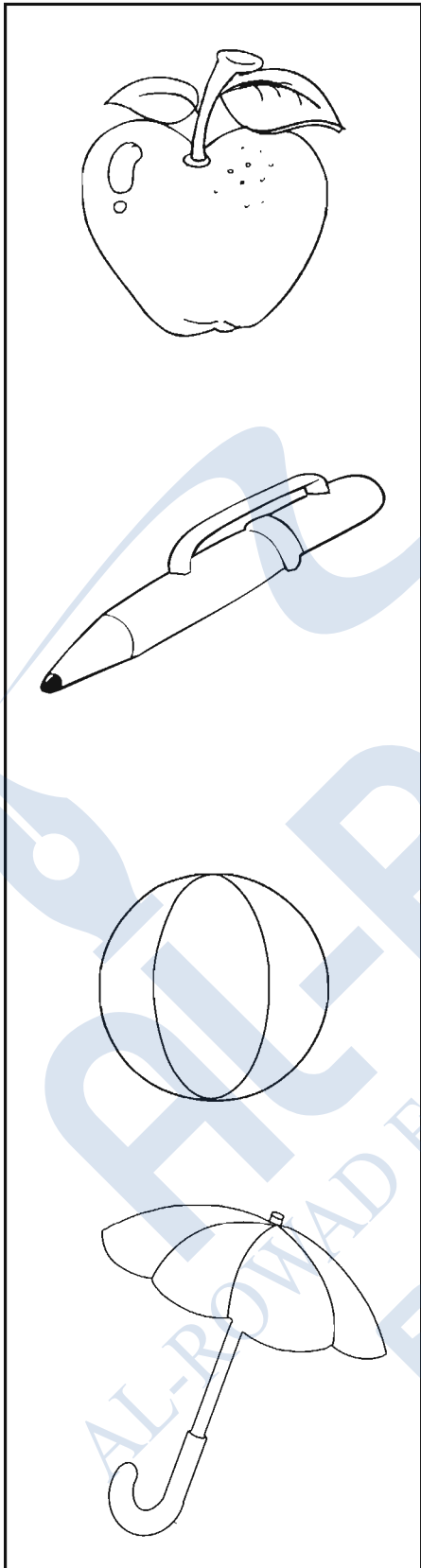

Match and say

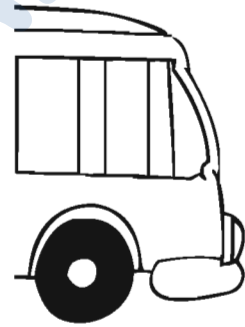
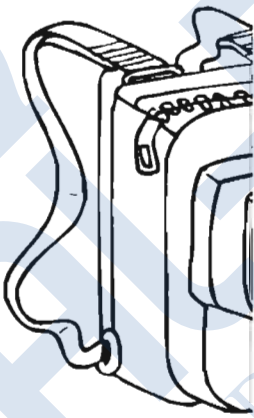
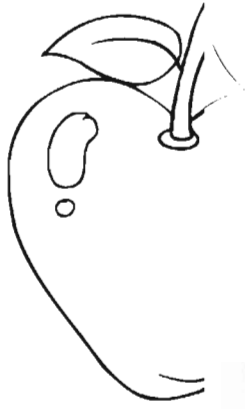

Write:

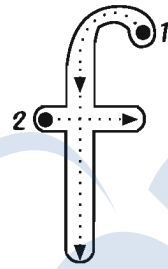
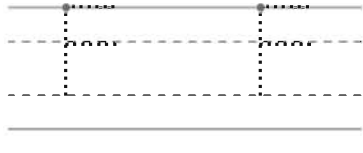
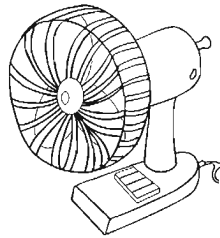
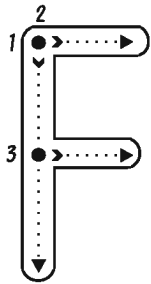

fan



Write:

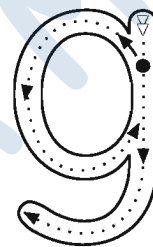
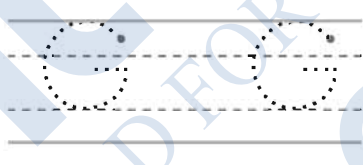
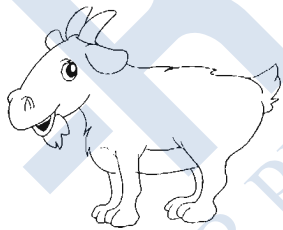

goat

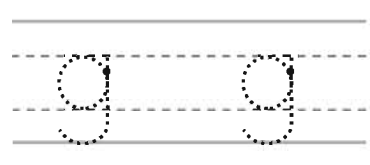

Write:

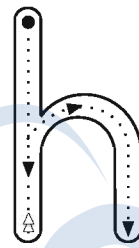
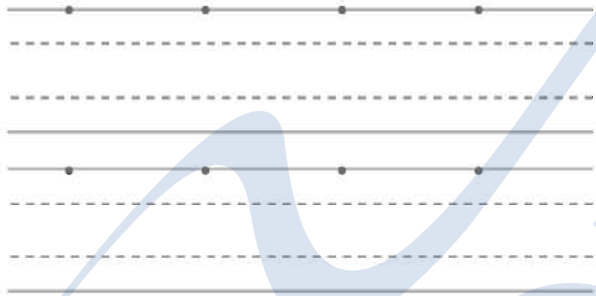
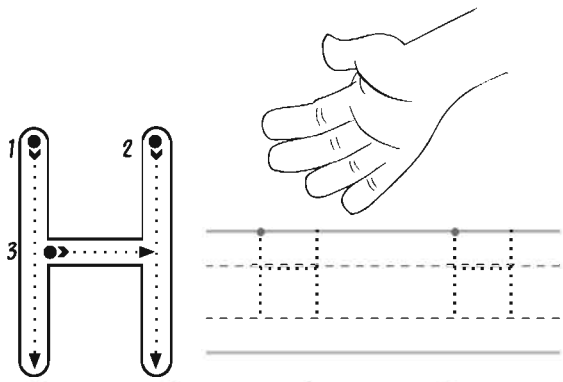

hand



Write:

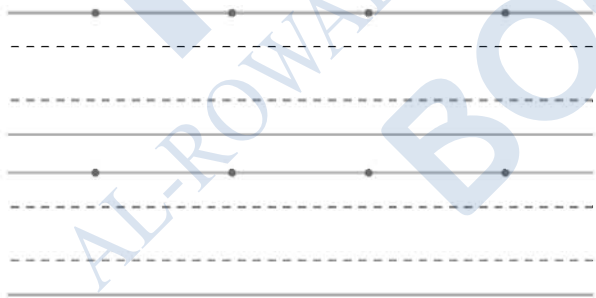
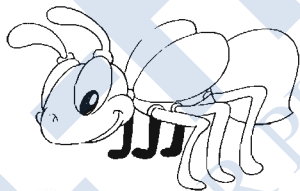

insect

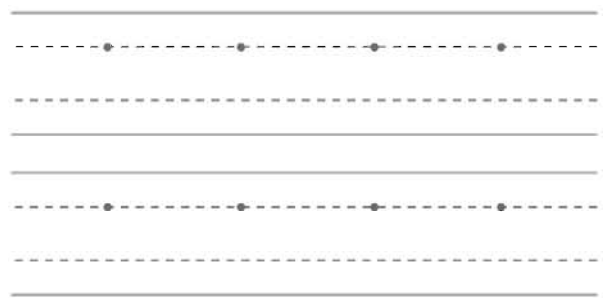

Write:

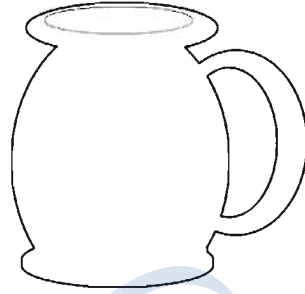
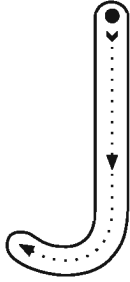

jug

