

الكتابة الأولى



الكتاب الثاني

أتعلم الألوان



الون

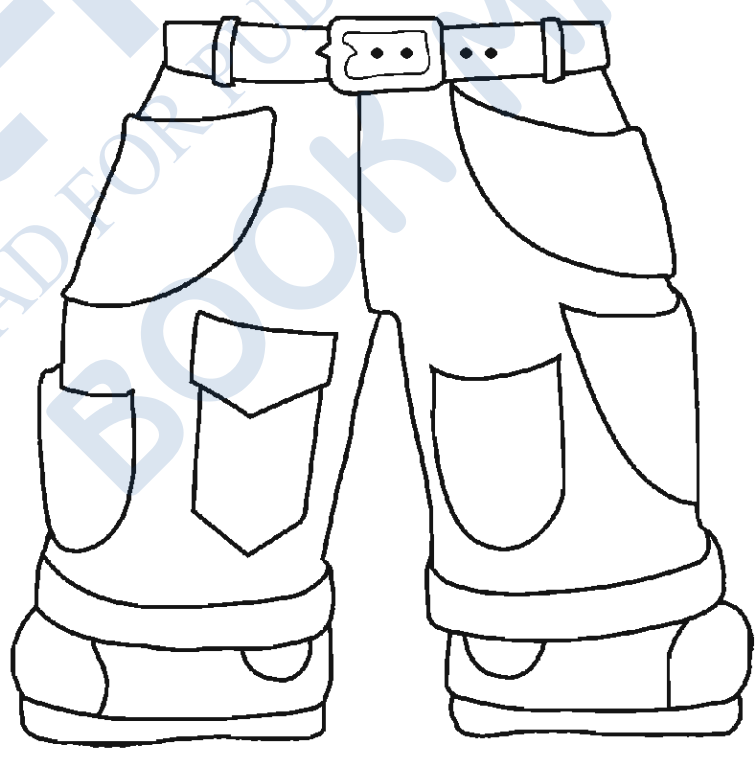
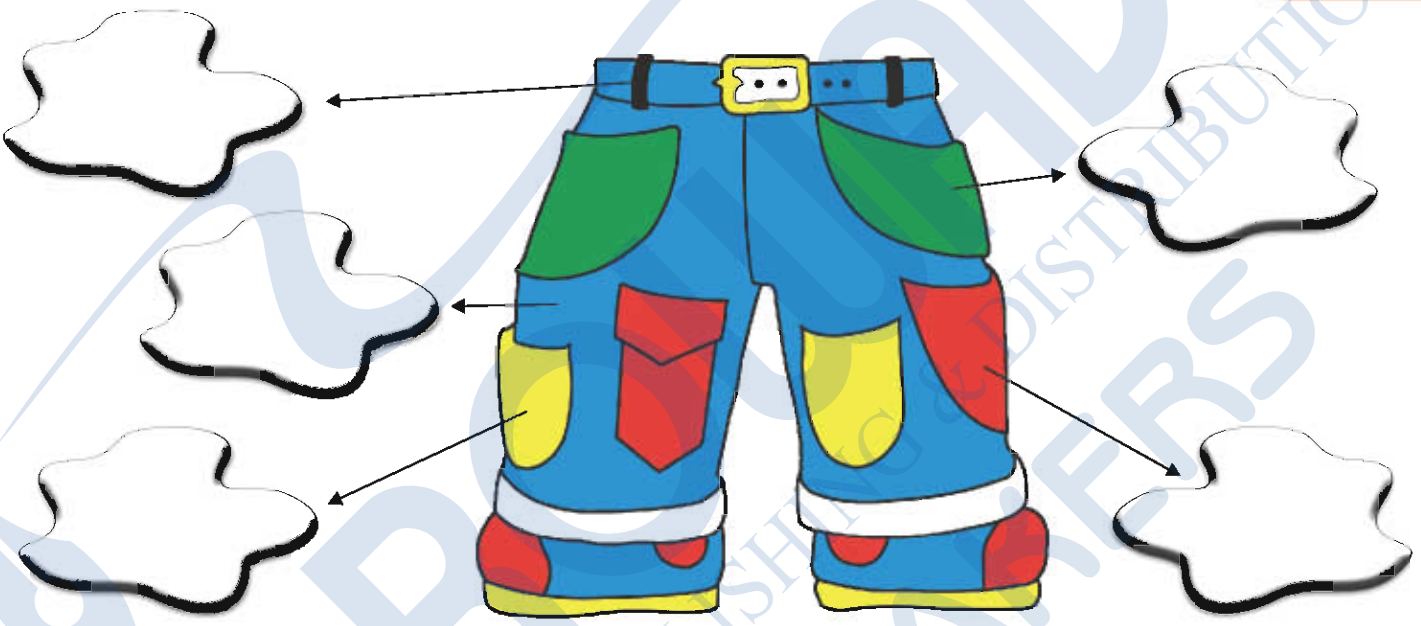

أتعلم الأشكال

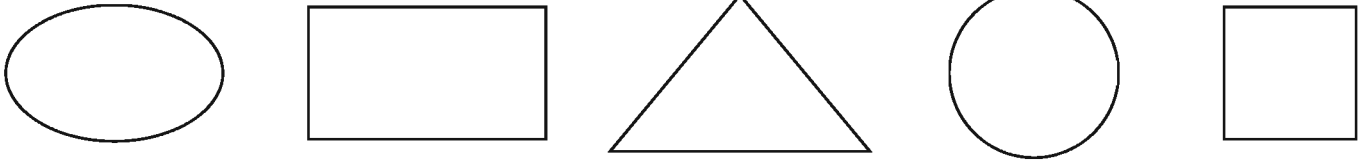

أصل

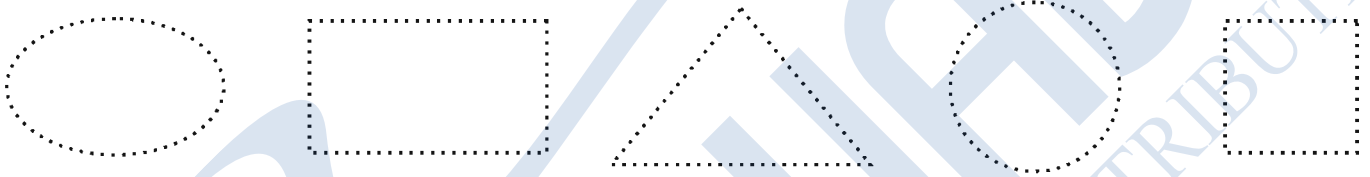

ألون

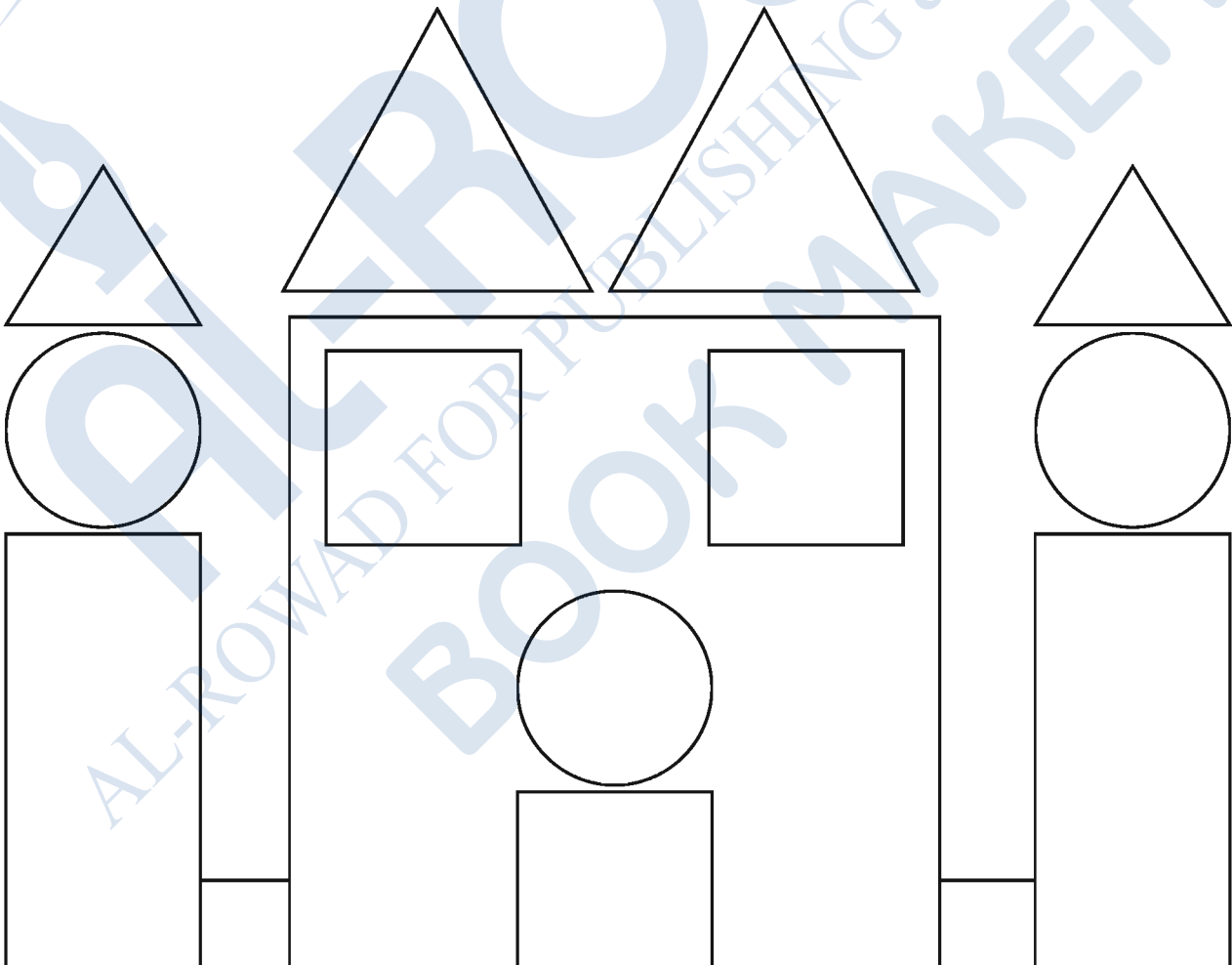

أصل الشكل واللون المشابه

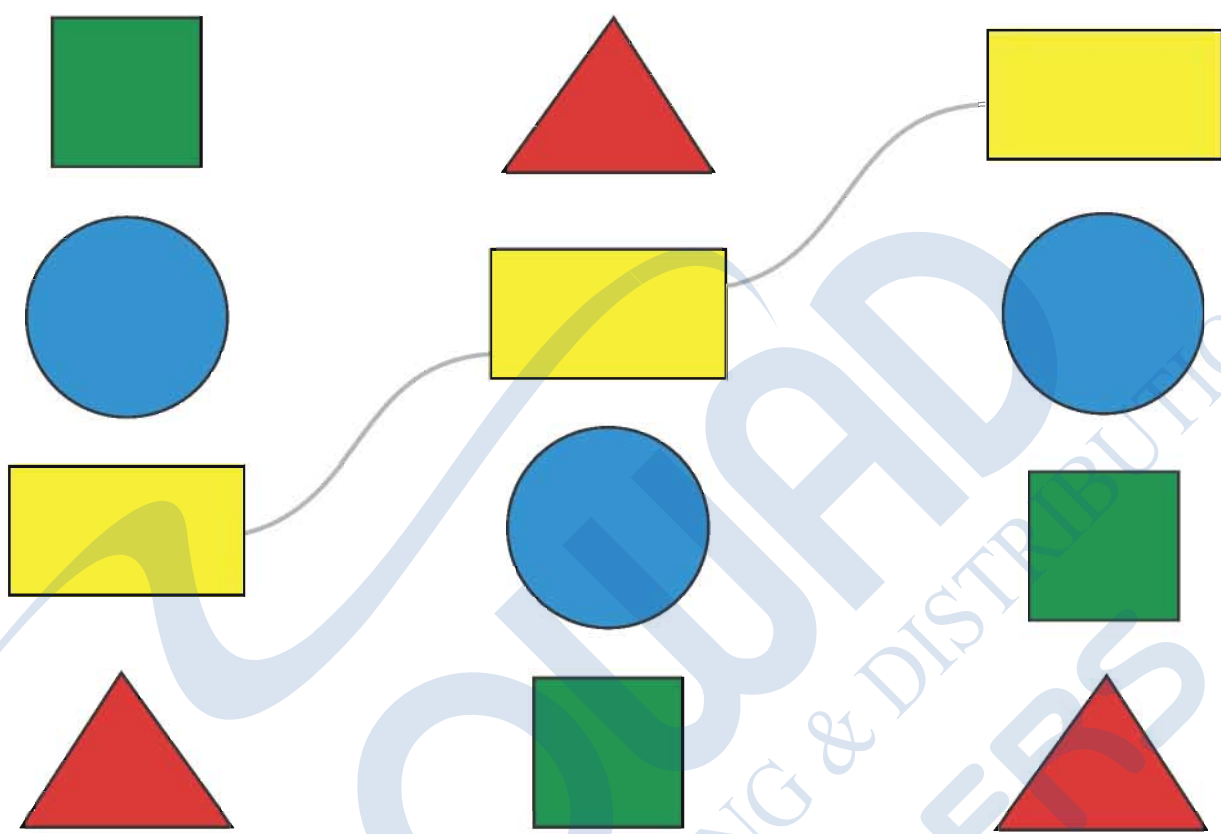

أصل الشكل والرقم المشابه

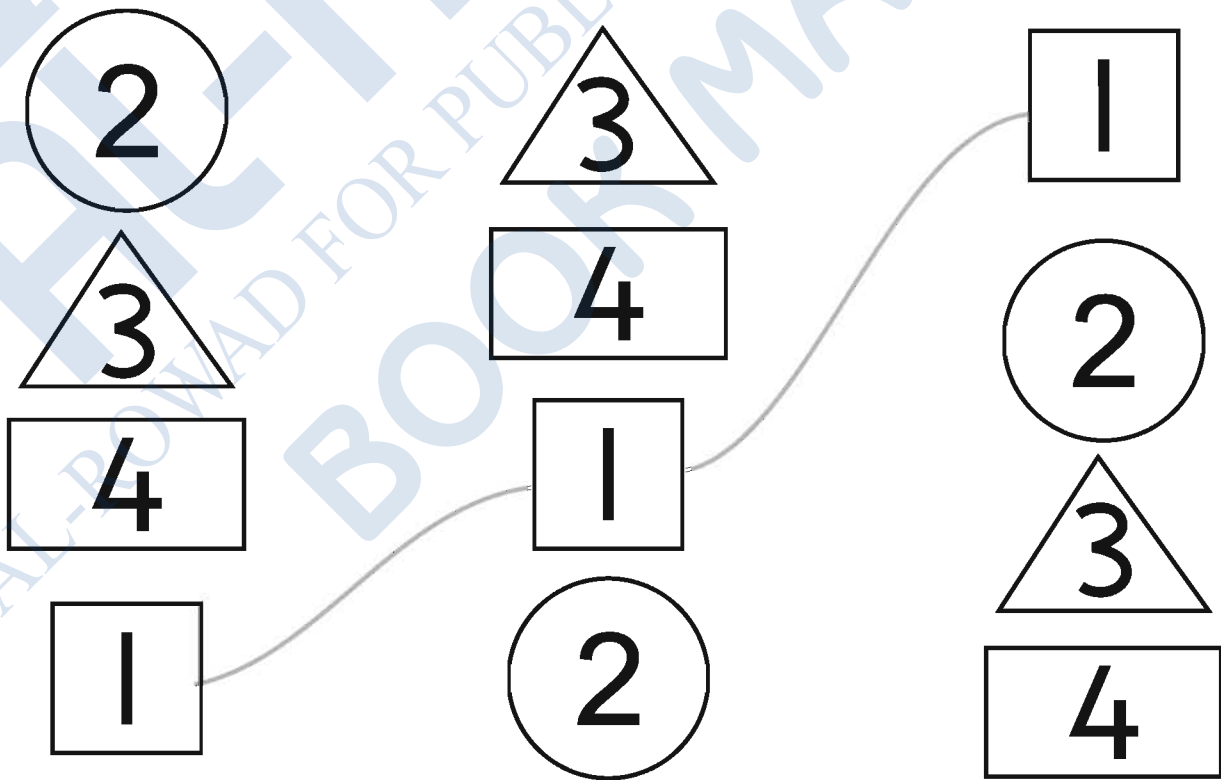

أضع حول العنصر المختلف

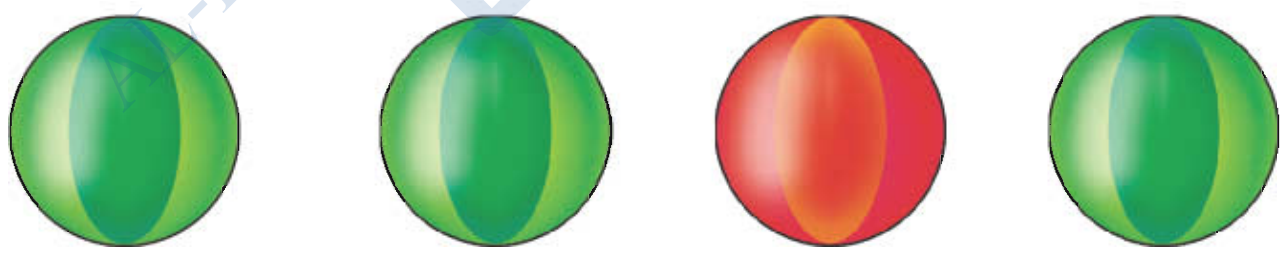
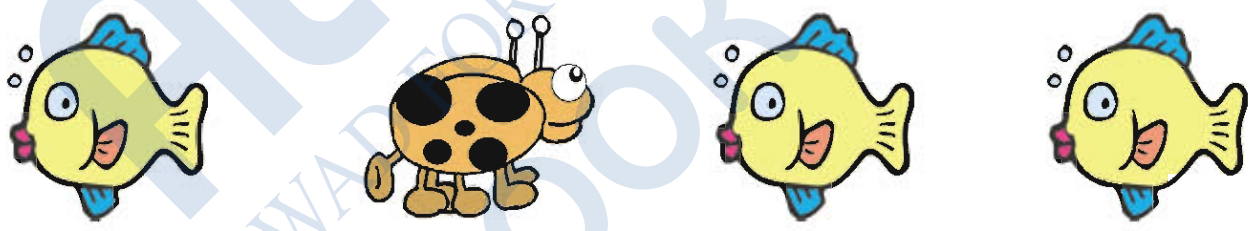

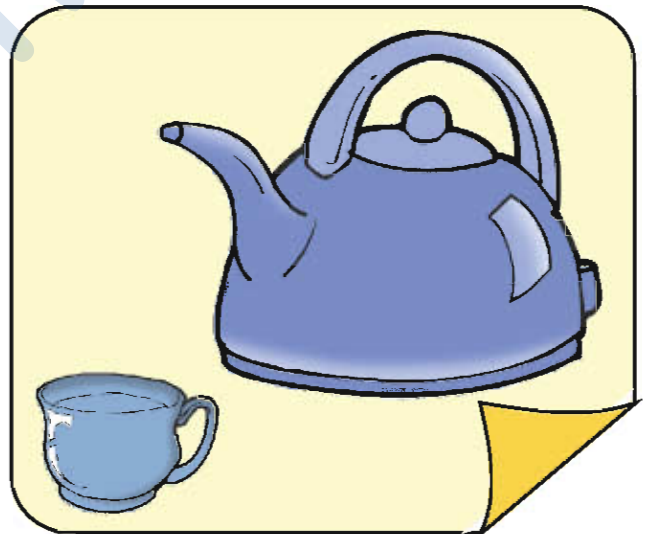
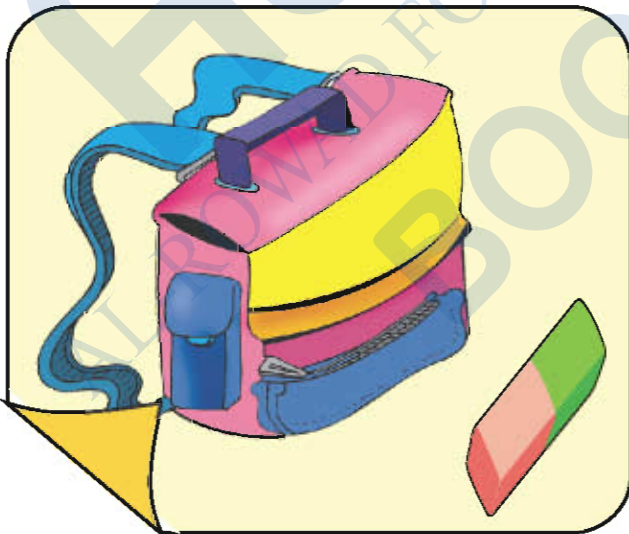
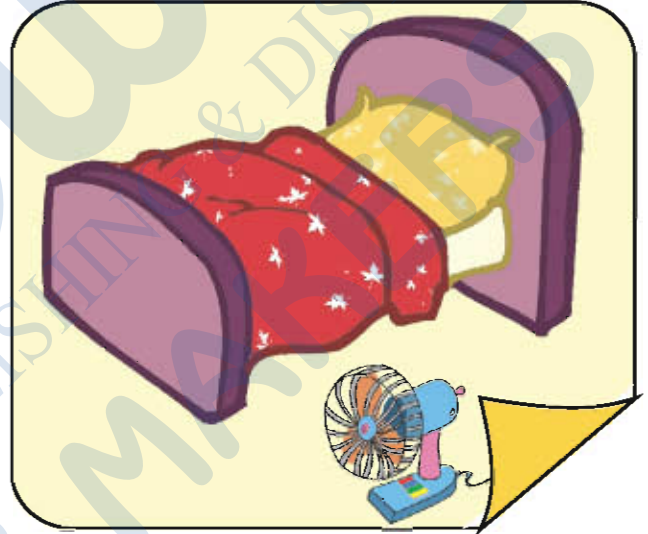
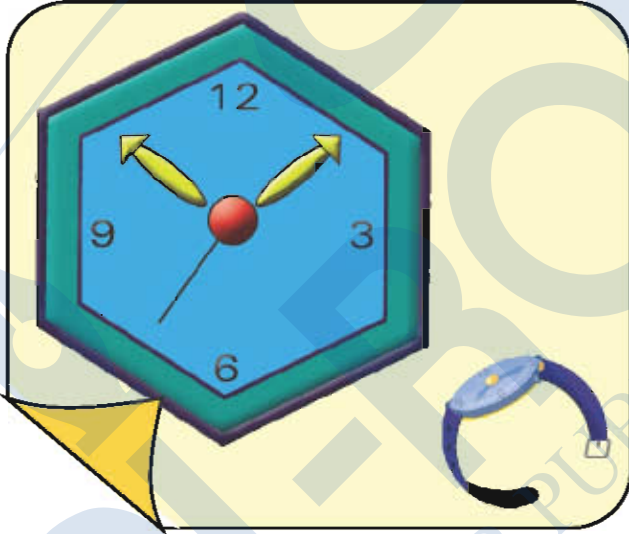
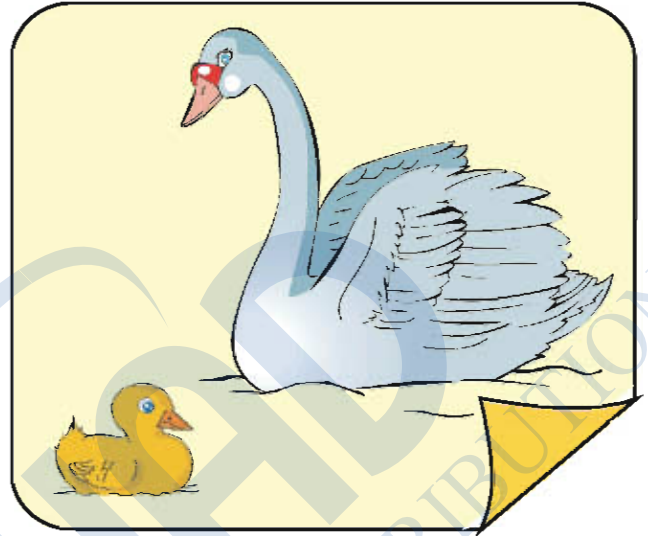
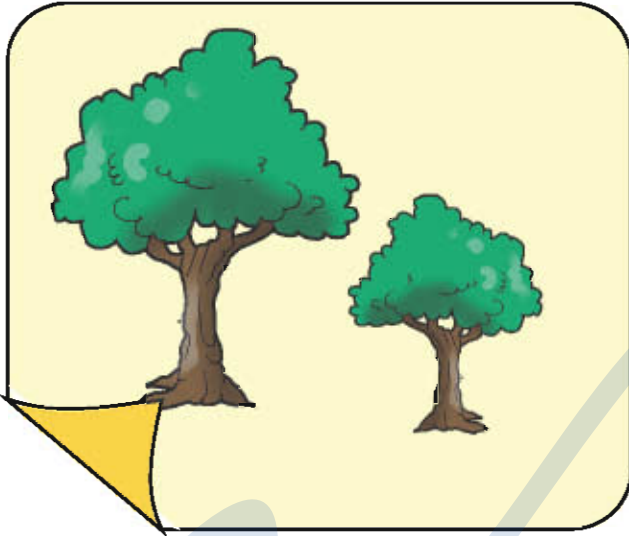

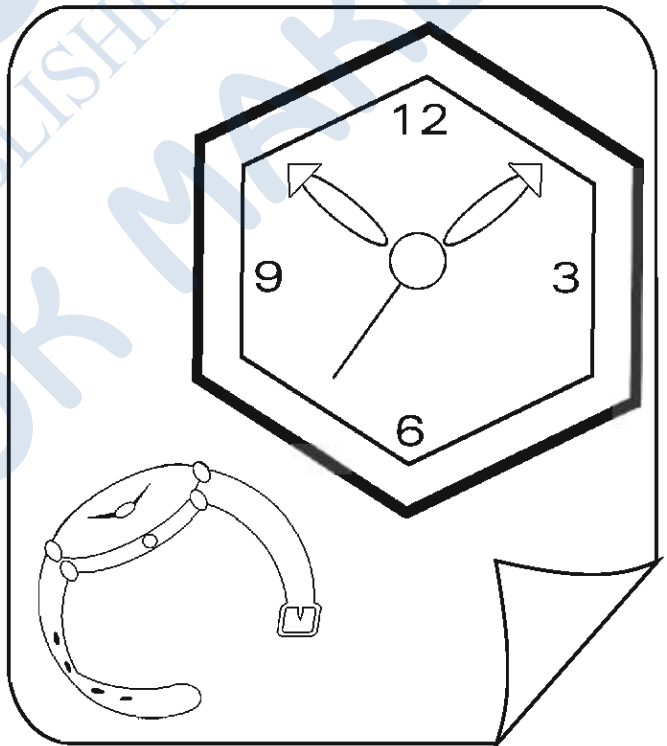
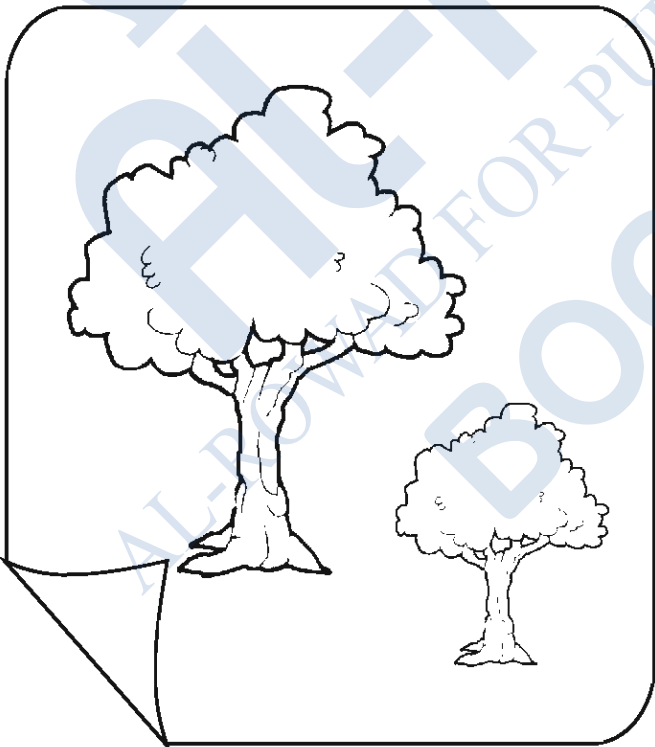
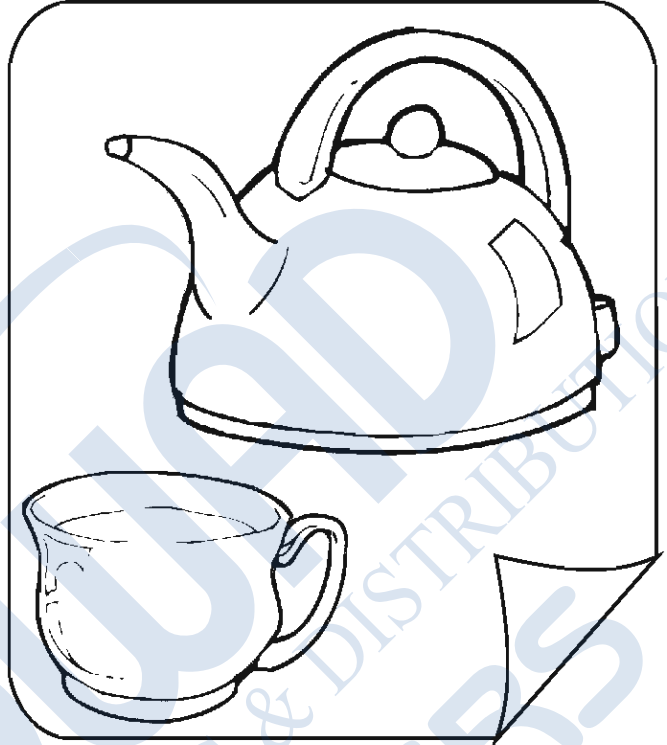
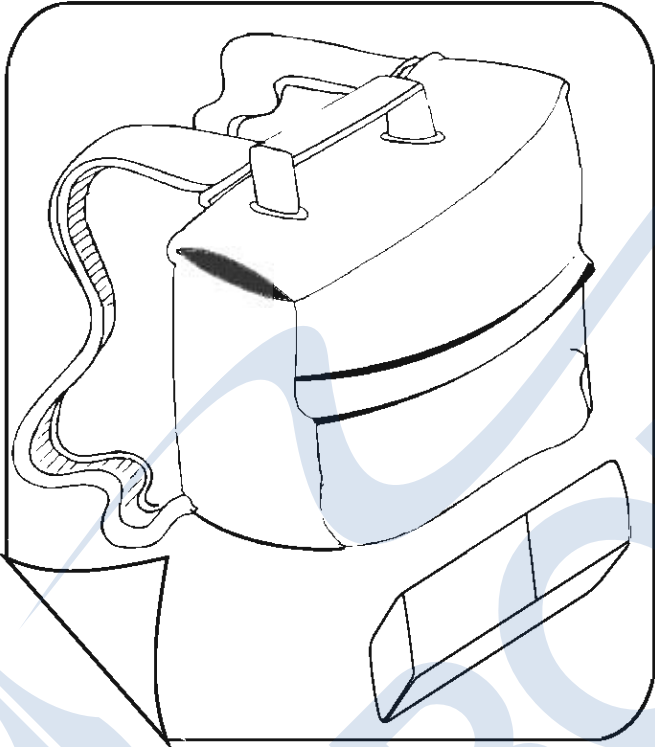

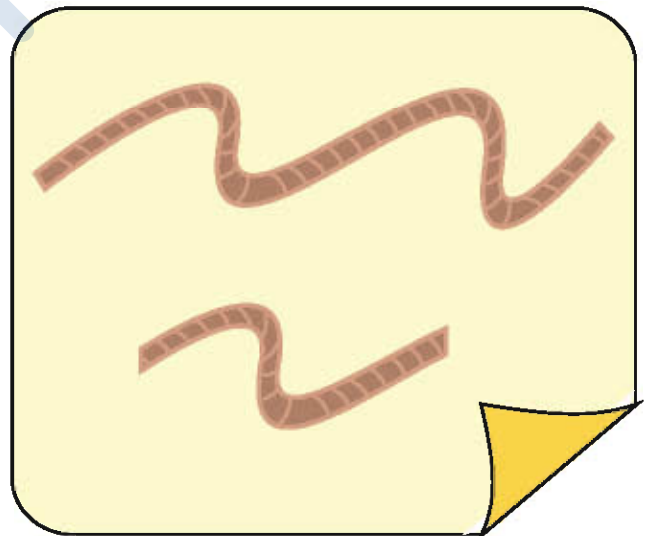
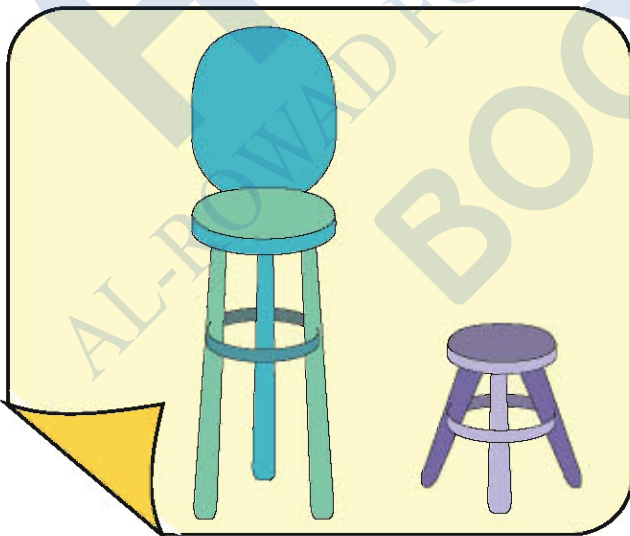
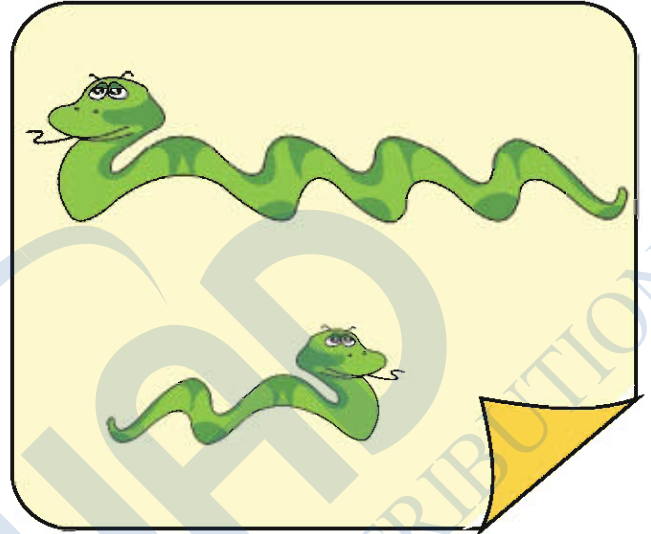
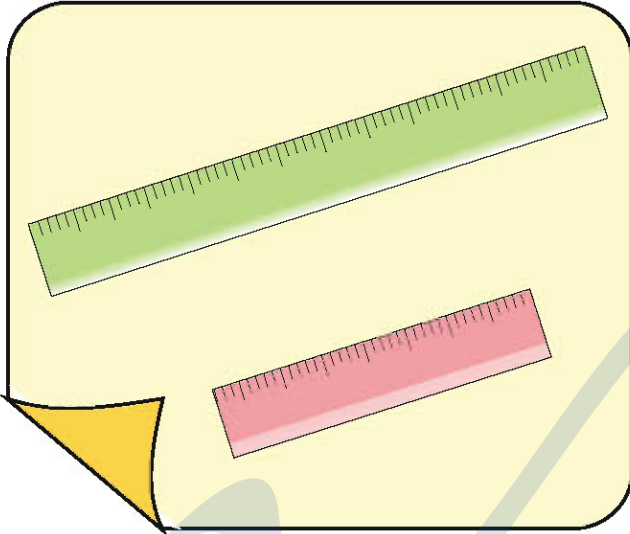

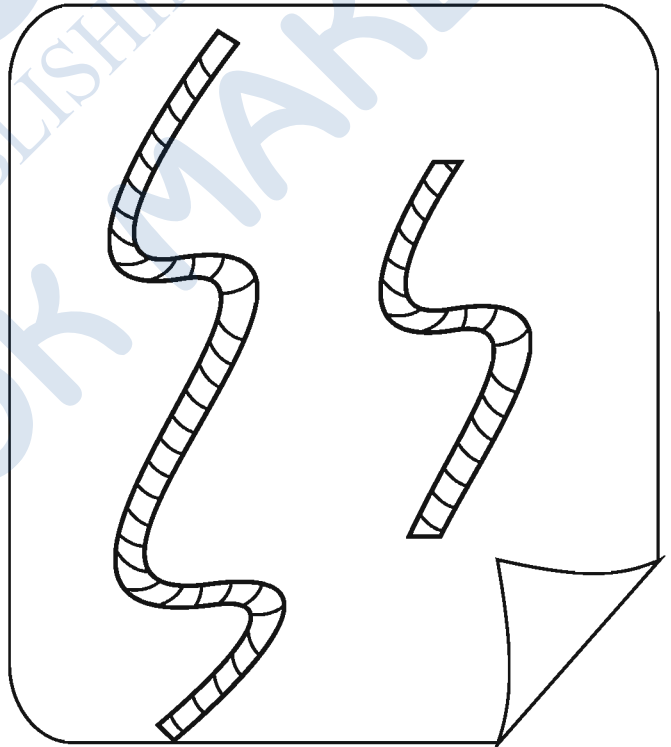
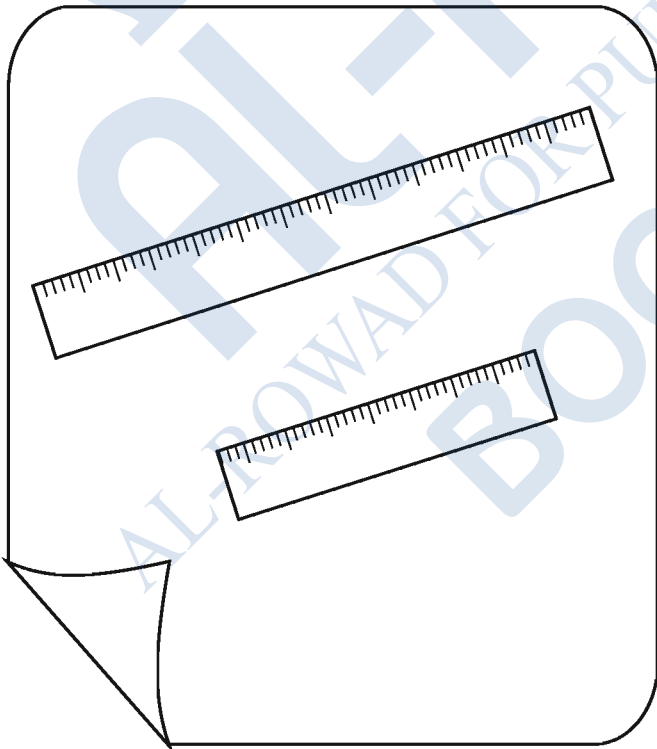
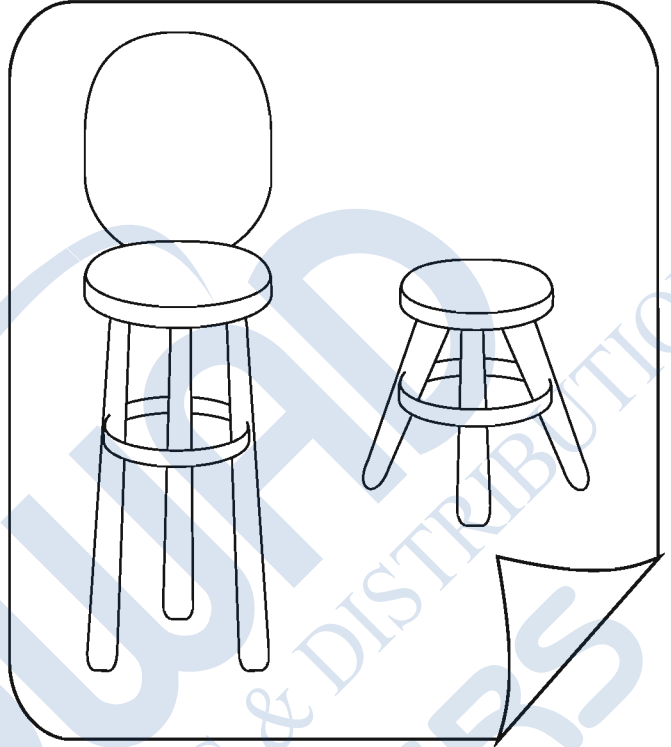
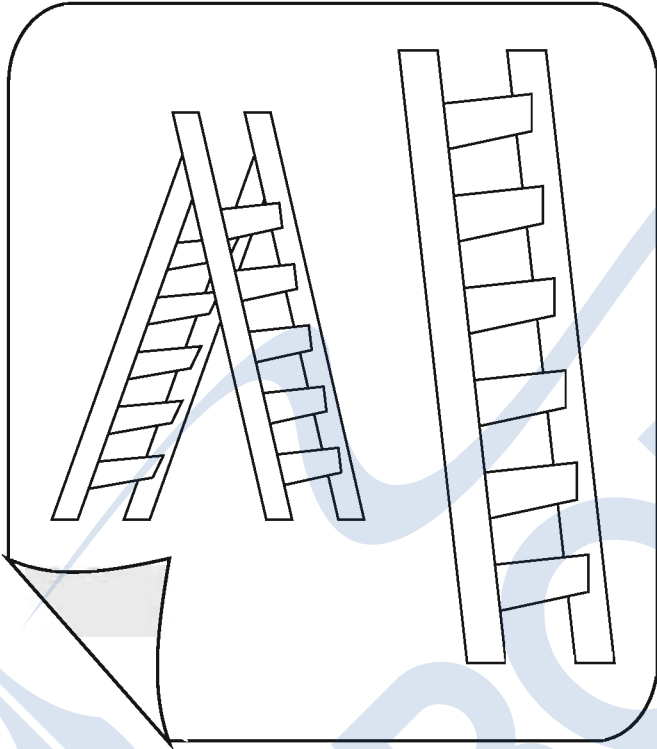

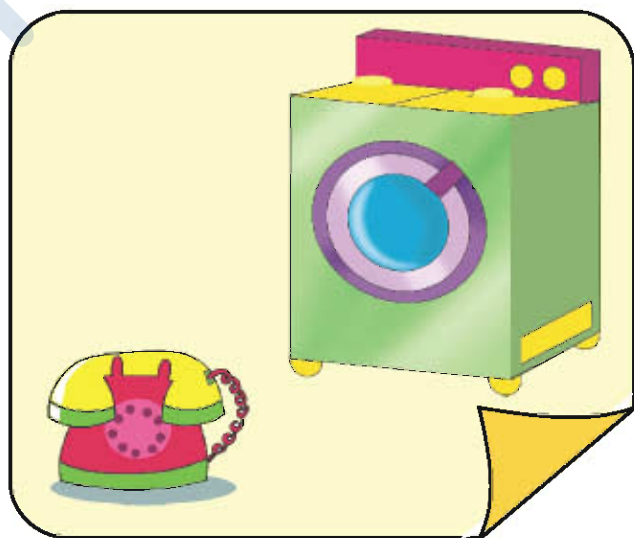
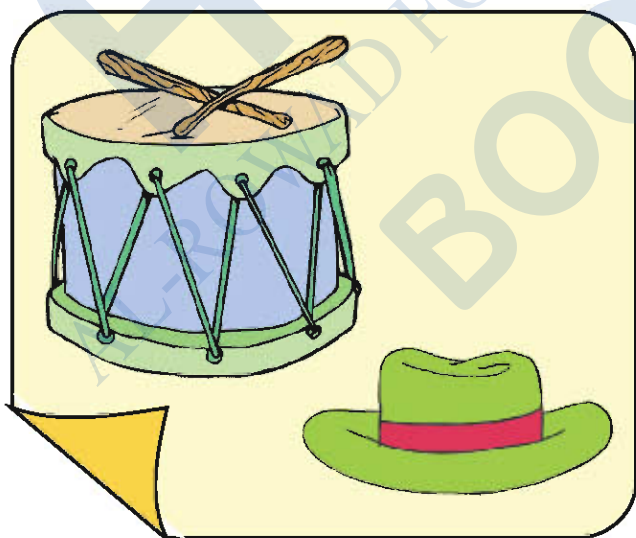
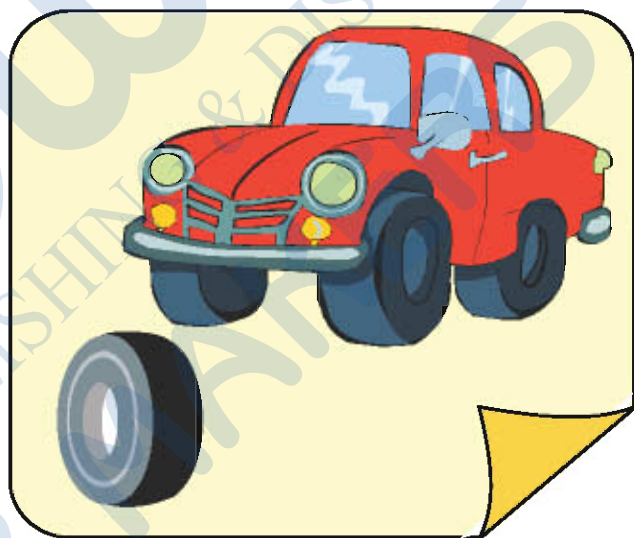
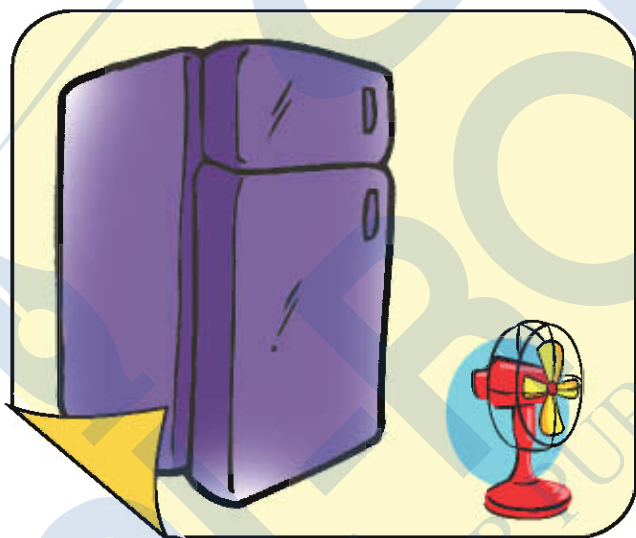
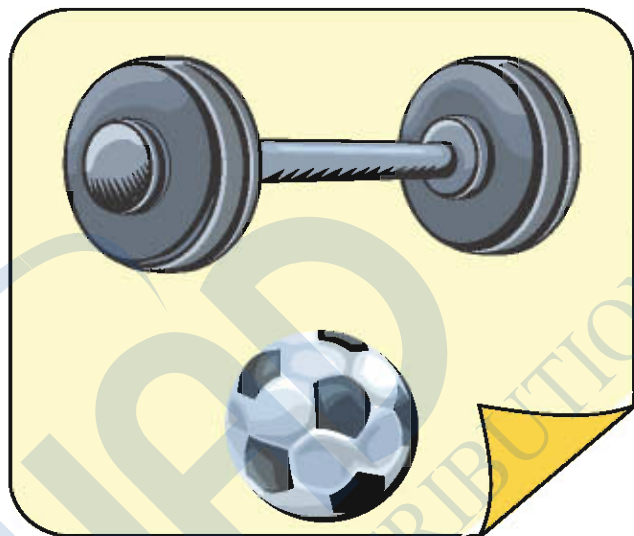
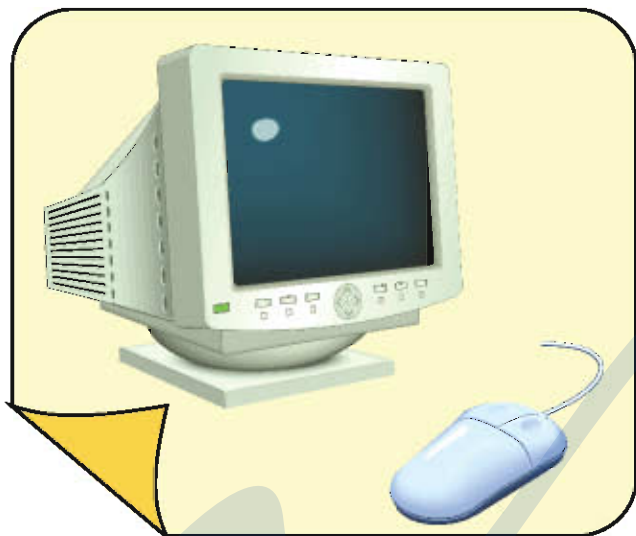

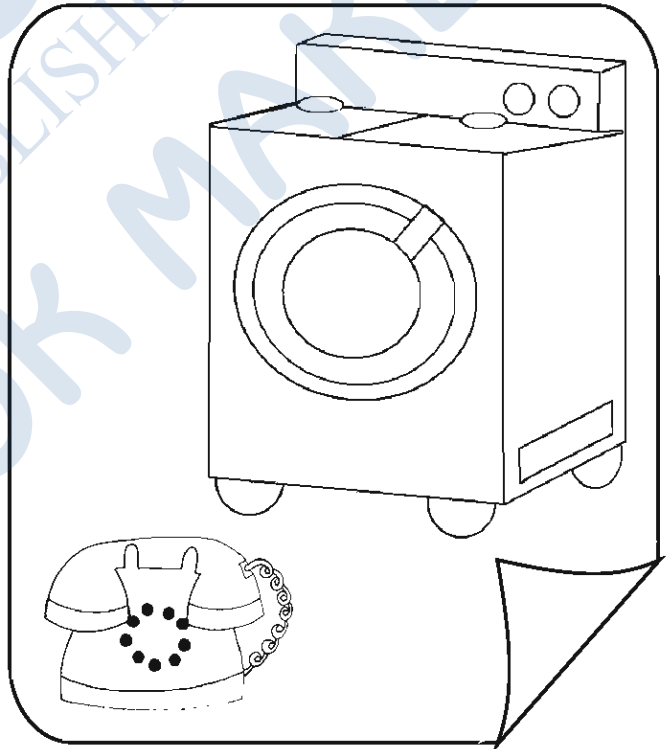
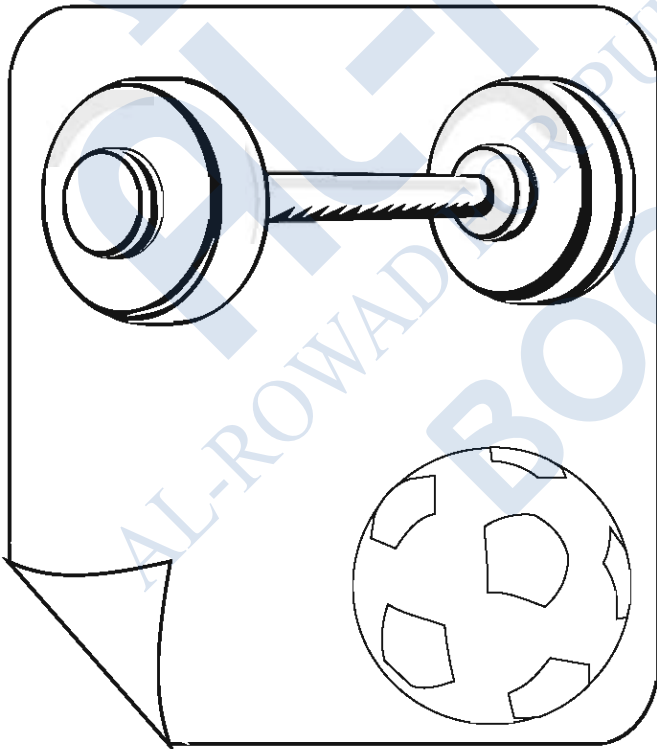
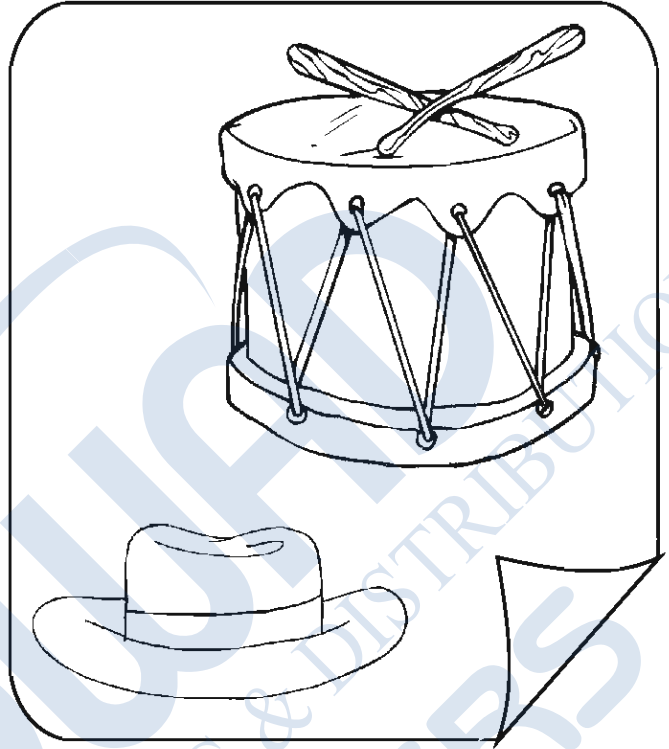
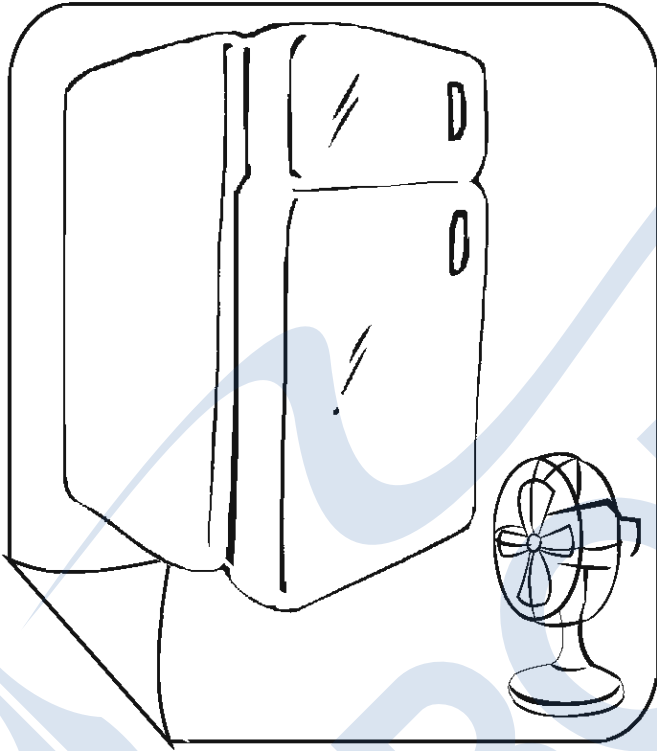

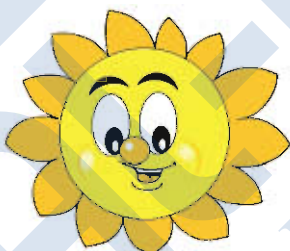

1

2

3

اكتب:

.....

.....

.....

اتعلم



اكتب:

↓	↓	↓	↓	⋮	⋮	⋮	⋮
⋮							

ألون عنصراً واحداً من كل مجموعة:

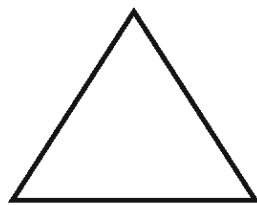
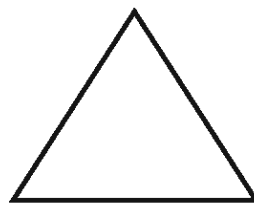
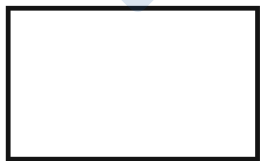
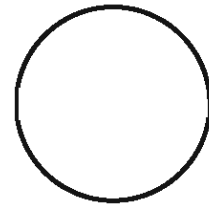
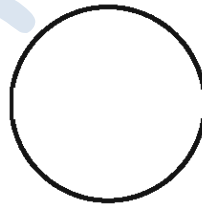

2

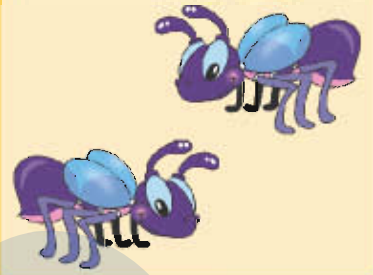
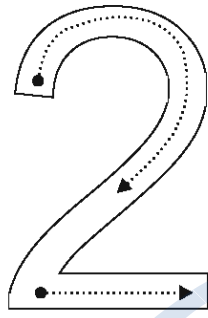

اكتب:

2	2	2	2	2	2	2	2
2							

أضع دائرة حول الرقم المناسب



1 2

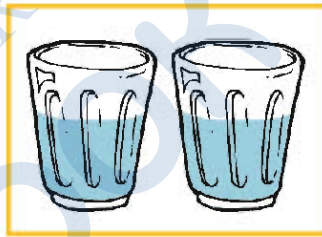

1 2



1 2

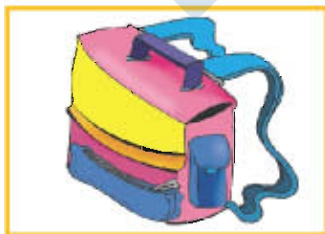

1 2

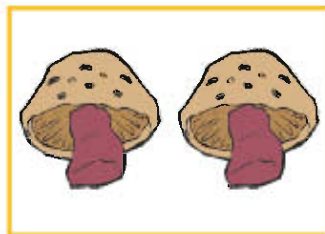

1 2